

<b>PRECAUTIONS</b>	<b>47</b>	Digital programmer	56
General safety instructions	47	Using the oven	57
Appliance purpose	51	Steam-assisted cooking	60
This user manual	51	Cooking advice	64
Manufacturer's liability	51	Mini guide to accessories	65
Identification plate	51	Discover the recipes	65
Disposal	51	Information for Supervisory Bodies	65
Information for European Control Bodies	51	Special functions	66
Energy efficiency technical data	52	Settings	69
To save energy	52	<b>CLEANING AND MAINTENANCE</b>	<b>72</b>
Light sources	52	Cleaning the appliance	72
How to read the user manual	52	Cleaning the door	72
<b>DESCRIPTION</b>	<b>53</b>	Cleaning the oven cavity	73
General description	53	Special cleaning functions	74
Control panel	54	Vapor Clean (on some models only)	74
Other parts	54	Pyrolytic (on some models only)	76
Accessories	55	Cleaning the water circuit	77
Advantages of assisted steam cooking	55	Extraordinary maintenance	81
<b>USE</b>	<b>56</b>	<b>INSTALLATION</b>	<b>82</b>
Preliminary operations	56	Electrical connection	82
Using the accessories	56	Positioning	82

We advise you to read this manual carefully, which contains all the instructions for maintaining the appliance's aesthetic and functional qualities. For further information on the product: [www.smeg.com](http://www.smeg.com)

## PRECAUTIONS

### General safety instructions

#### Risk of personal injury

- **ATTENTION:** during use, the appliance and its accessible parts become very hot. Children must be kept away from the appliance.
- **ATTENTION:** during use, the appliance and its accessible parts become very hot. Never touch the heating elements during use.
- Protect your hands by wearing oven gloves when moving food inside the oven.
- Never try to put out a fire or flames with water: turn off the appliance and smother the flames with a fire blanket or other appropriate cover.
- This appliance may be used by children aged at least 8 and by people of reduced physical, sensory or mental capacity, or lacking in experience in the use of electrical appliances, provided that they are supervised or instructed by adults who are responsible for their safety.
- Children must not play with the appliance.
- Keep children under the age of

8 at a safe distance unless they are constantly supervised.

- Keep children under the age of 8 away from the appliance when it is in use.
- Cleaning and maintenance must not be carried out by unsupervised children.
- The cooking process must always be monitored. A short cooking process must be continuously surveyed.
- Never leave the appliance unattended during cooking operations where fats or oils could be released, as these could then heat up and catch fire. Be very careful.
- Do not pour water directly onto very hot trays.
- Keep the oven door closed during cooking.
- If you need to move food or at the end of cooking, open the door 5 cm for a few seconds, let the steam come out, then open it fully.
- Do not insert pointed metal objects (cutlery or utensils) into the slots in the appliance.
- Switch off the appliance immediately after use.
- DO NOT USE OR STORE FLAMMABLE MATERIALS NEAR THE APPLIANCE.
- DO NOT USE AEROSOLS IN THE VICINITY OF THIS APPLIANCE WHILST IT IS IN USE.

- DO NOT MODIFY THIS APPLIANCE.
- Installation and servicing should be carried out by qualified personnel in accordance with current standards.
- Do not try to repair the appliance yourself or without the assistance of a qualified technician.
- Do not pull the cable to unplug the appliance.

### **Risk of damaging the appliance**

- Do not use abrasive or corrosive detergents (e.g. scouring powders, stain removers and metallic sponges), rough or abrasive materials or sharp metal scrapers on glass parts as this could cause scratch the surface and break the glass. Use wooden or plastic utensils.
- Do not sit on the appliance.
- Do not use cleaning products containing chlorine, ammonia or bleach on parts made of steel or that have metallic surface finishes (e.g. anodizing, nickel- or chromium-plating).
- Racks and trays should be inserted as far as they will go into the side guides. The mechanical safety locks that prevent them from being removed must face downwards and towards the back of the

oven cavity.

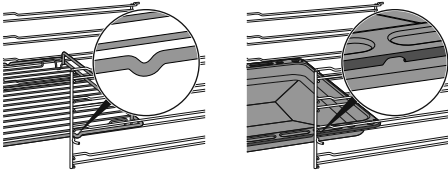

- Do not use steam jets to clean the appliance.
- Do not spray any spray product near the appliance.
- Do not obstruct ventilation openings and heat dispersal slots.
- Fire hazard: never leave objects in the oven cavity.
- **DO NOT FOR ANY REASON USE THE APPLIANCE AS A SPACE HEATER.**
- Do not use plastic cookware or containers when cooking food.
- Do not place sealed tins or containers in the oven cavity.
- Remove all trays and racks which are not required during cooking.
- Do not cover the bottom of the oven cavity with aluminium or tin foil sheets.
- Do not place pans or trays directly on the bottom of the oven cavity.
- If necessary, you can use the tray rack (supplied or sold separately, depending on the model) by placing it on the bottom as a support for cooking.
- If you wish to use greaseproof paper, place it so that it will not

interfere with the hot air circulation inside the oven cavity.

- Do not use the open door to rest pans or trays on the internal glass pane.
- Never use the oven door to lever the appliance into place when fitting.
- Avoid exerting too much pressure on the door when open.
- Do not use the handle to lift or move this appliance.

### For pyrolytic appliances

- When the pyrolytic function is in use, the surfaces could reach temperatures that are higher than usual. Keep children at a safe distance.
- Before starting the pyrolytic cycle, remove any food residues or large spills from previous cooking operations from the inside of the oven.
- Before starting the pyrolytic cycle, remove all accessories from the oven cavity.
- Before starting the pyrolytic cycle, switch off the burners or electric hot plates of the hob installed above the oven.

### Installation and maintenance

- **THIS APPLIANCE MUST NOT BE INSTALLED IN A BOAT OR CARAVAN.**
- The appliance must not be

installed on a pedestal.

- Position the appliance into the cabinet cut-out with the help of a second person.
- To prevent any possible overheating, the appliance should not be installed behind a decoration door or a panel.
- Installation and servicing should be carried out by qualified personnel in accordance with current standards.
- Have the electrical connection performed by authorised technical personnel.
- The appliance must be connected to ground in compliance with electrical system safety standards.
- Use cables withstanding a temperature of at least 90 °C.
- The tightening torque of the screws of the terminal supply wires must be 1.5 - 2 Nm.
- If the power cable becomes damaged, contact technical support immediately to arrange for it to be replaced in order to avoid possible hazards.
- Always use any necessary/required personal protective equipment (PPE) before performing any work on the appliance (installation, maintenance, positioning or movement).
- Before performing any operation on the appliance, switch off the power supply.
- Disconnect the appliance after the installation, through an accessible plug or switch in case of fixed connection.
- Fit the power line with an all-pole circuit breaker with a contact separation distance sufficient to provide complete disconnection in category III overvoltage conditions, pursuant to installation regulations.
- **WARNING:** Make sure that the appliance has been switched off and disconnected from the mains power supply or that the mains power has been switched off before replacing the interior lighting bulbs.
- The bulbs used in this appliance are specific for household appliances; do not use them for home lighting.
- This appliance can be used up to a maximum altitude of 2,000 metres above sea level.

### **For this appliance**

- **WARNING:** ensure that the appliance is switched off before replacing the bulb, to prevent electric shocks.
- Do not rest any weight or sit on the open door of the appliance.
- Take care that no objects are stuck in the doors.
- Do not install/use the appliance outdoors.

- (on some models only) Only use the temperature probe provided or recommended by the manufacturer.
- For cooking with the Direct Steam function, take great care not to exceed the maximum capacity of the tray (250 ml).

## Appliance purpose

This appliance is intended for cooking food in the home environment. Every other use is considered inappropriate. It cannot be used:

- in employee kitchens, shops, offices and other working environments.
- in farms/farmhouses.
- by guests in hotels, motels and residential environments.
- In bed and breakfast accommodation.

## This user manual

- This user manual is an integral part of the appliance and must therefore be kept in its entirety and within the user's reach for the whole working life of the appliance.
- Read this user manual carefully before using the appliance.
- The explanations in this manual include images, which describe all that regularly appears on the display. However, it should be kept in mind that the appliance may be equipped with an updated version of the system, and as such, all that appears on the display may differ from those in the manual.

## Manufacturer's liability

The manufacturer declines all liability for damage to persons or property caused by:

- use of the appliance other than that specified;
- failure to comply with the instructions in the user manual;

- tampering with any part of the appliance;
- use of non-original spare parts.

## Identification plate

The identification plate bears the technical data, serial number and brand name of the appliance. Do not remove the identification plate for any reason.

## Disposal



This appliance conforms to the WEEE European directive (2012/19/EU) and must be disposed of separately from other waste at the end of its service life.

The appliance does not contain substances in quantities sufficient to be considered hazardous to health and the environment, in accordance with current European directives.



### Power voltage Danger of electrocution

- Disconnect the mains power supply.
- Unplug the appliance.

To dispose of the appliance:

- Cut the power cable and remove it.
- Deliver the appliance to the appropriate recycling centre for electrical and electronic equipment waste, or return it to the retailer when purchasing an equivalent product, on a one for one basis.

Our appliances are packaged in non-polluting and recyclable materials.

- Deliver the packing materials to the appropriate recycling centre.



### Plastic packaging Danger of suffocation

- Do not leave the packaging or any part of it unattended.
- Do not let children play with the plastic bags.

## Information for European Control Bodies

### Fan forced mode

the ECO function used to define the energy efficiency class complies with the specifications of European standard EN 60350-1.

### Conventional heating mode

To run the STATIC function, the preheating

phase must be skipped (see section "Preheating phase" in the USE chapter).

## Energy efficiency technical data

Information in accordance with the European energy labelling and ecodesign regulations is contained in a separate document accompanying the product instructions.

These data are present in the "Product information sheet" that can be downloaded from the website at the page dedicated to the product in question.

## To save energy

- Only preheat the appliance if the recipe requires you to do so. The preheating stage can be disabled for all functions (see chapter "Preheating") apart from the PIZZA (preheating cannot be disabled) and ECO functions (no preheating stage).
- When using the functions (including the ECO function), avoid opening the door during cooking.
- Unless otherwise indicated on the package, defrost frozen foods before placing them in the oven.
- When cooking several types of food it is recommended to cook the foods one after the other to make the best use of the already hot oven.
- Use dark metal moulds: They help to absorb the heat better.
- Remove all trays and racks which are not required during cooking.
- Stop cooking a few minutes before the time normally used. Cooking will continue for the remaining minutes with the heat which has accumulated inside the oven.
- Reduce any opening of the door to a minimum to avoid heat dispersal.
- Keep the inside of the oven clean at all times.

## Light sources

- This appliance contains user-replaceable light sources.

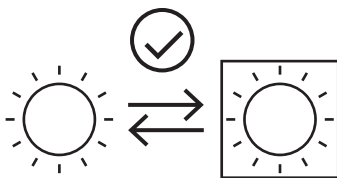



- The light sources contained in the appliance

are declared suitable for operation at ambient temperature  $\geq 300^{\circ}\text{C}$  and intended for use in high temperature applications such as ovens.

- This appliance contains light sources of efficiency class "G".

## How to read the user manual

This user manual uses the following reading conventions:

	Warning/ Caution
	Information/ Advice

# DESCRIPTION

## General description

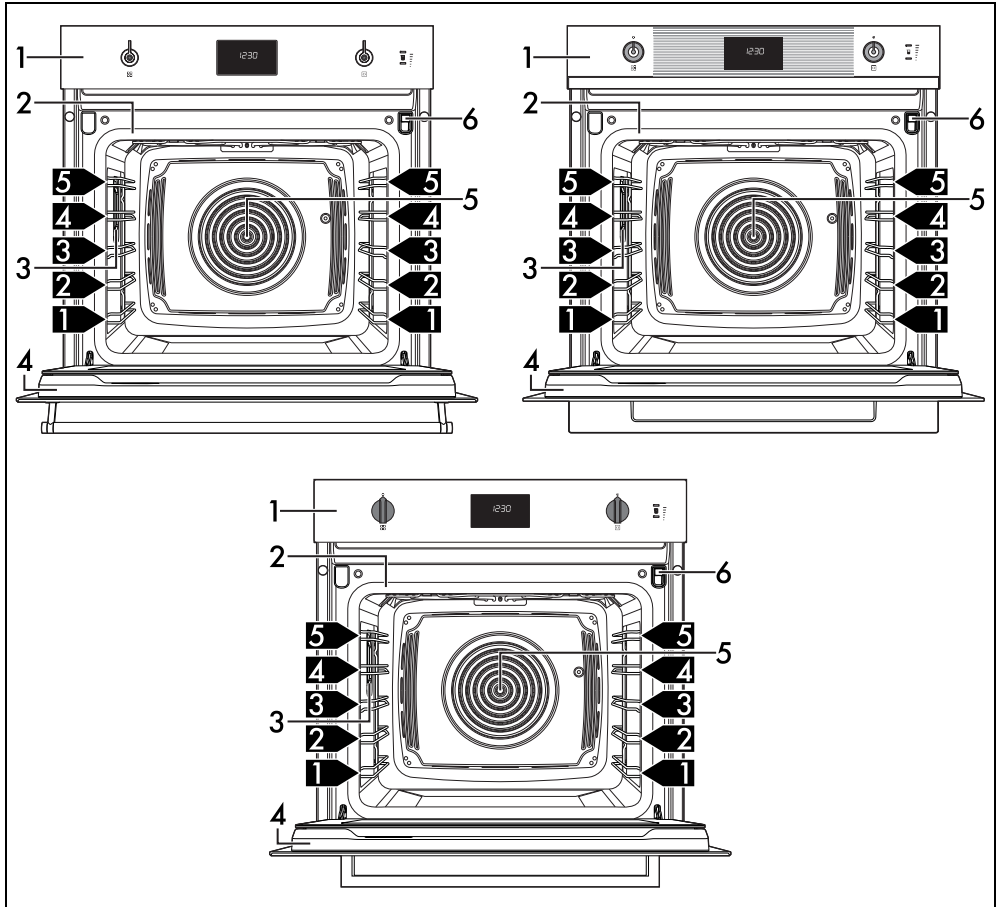

- 1 Control panel
- 2 Seal
- 3 Oven light
- 4 Door
- 5 Fan
- 6 Water reservoir
- 1,2,3** Frame shelf

## Control panel

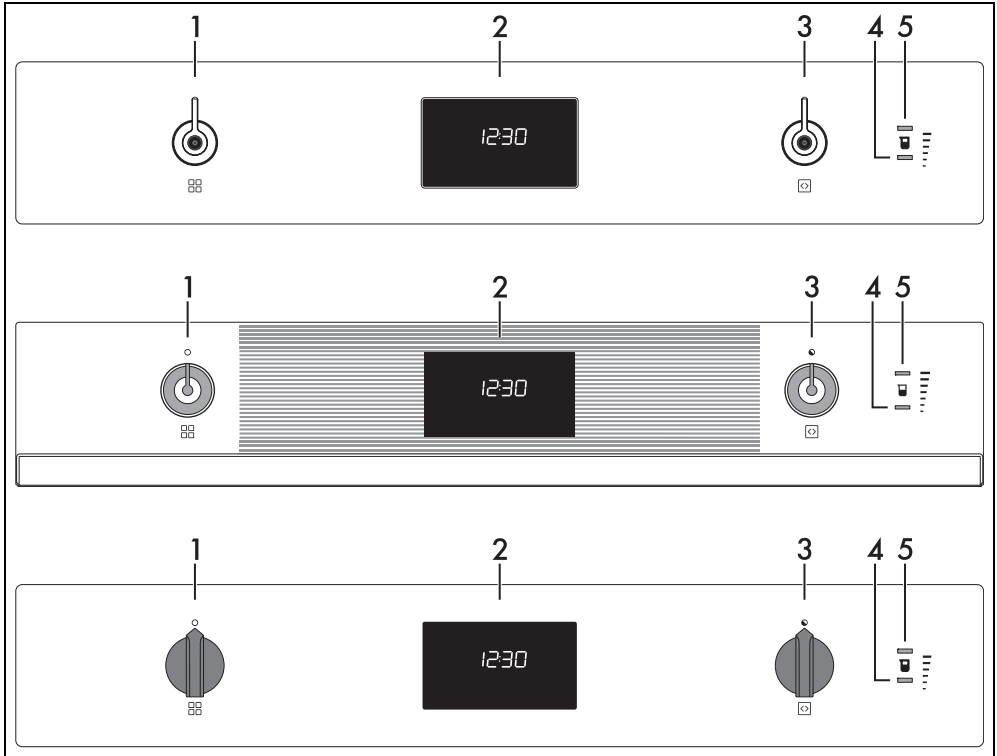

### 1 Function knob

This knob can be used to:

- turn the appliance on and off;
- select a function.



Turn the Function knob to the position 0 to immediately complete any cooking operation.

### 2 Digital programmer

Displays the current time, the minute minder, the function, the steam percentage, the selected cooking temperature, power and any time set.

### 3 Temperature knob

This knob can be used to set:

- the cooking temperature;
- the duration of a function;
- programmed cooking cycles;
- the current time.

### 4 Min. level indicator light

Comes on to indicate that the liquid inside the reservoir has reached the minimum level for an assisted steam function.

### 5 Max. level indicator light

Comes on to indicate that the liquid inside the reservoir has reached the maximum level for an assisted steam function.

## Other parts

### Shelves

The appliance features shelves to position trays and racks at different heights. The insertion heights are indicated from the bottom upwards.

### Cooling fan

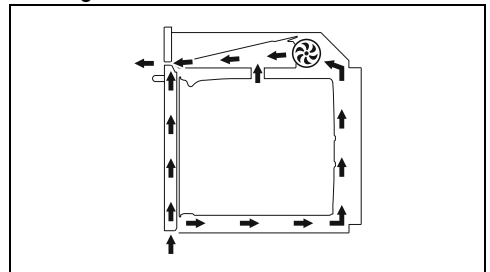

The fan cools the appliance and comes into operation during cooking.



The fan causes a steady outflow of air from above the door which may continue for a short period of time even after the appliance has been turned off.

### Oven cavity lighting

- The lighting of the oven cavity is activated when any cooking function is selected, excluding the **ECO** function.
- The interior lighting remains switched off during the execution of the **DEFr** - **PrOv** - **SABb** special functions and the **CLEA** - **Pyro** cleaning functions (depending on the models).
- When the door is opened, excluding the **SABb** function, the lighting in the oven cavity is switched on. It switches off immediately when the door is closed.
- When the door is open, it is not possible to turn off the interior lighting.

### Accessories

- Not all accessories are available on some models.
- The accessories intended to come into contact with food are made of materials that comply with the provisions of current legislation.
- Original supplied and optional accessories can be requested to Authorised Assistance Centres. Use only original accessories supplied by the manufacturer.

### Rack

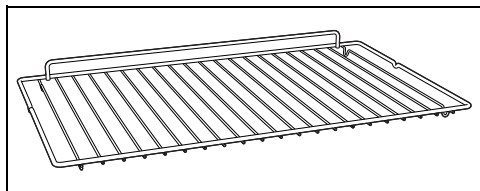

Used for supporting containers with food during cooking.

### Deep tray

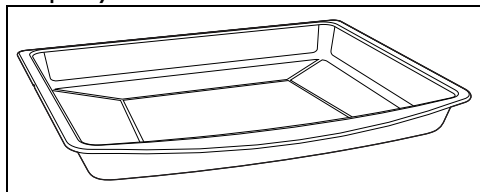

Useful for collecting fat from foods placed on

the rack above and for cooking pies, pizzas, baked desserts, biscuits, etc.

### Tray rack

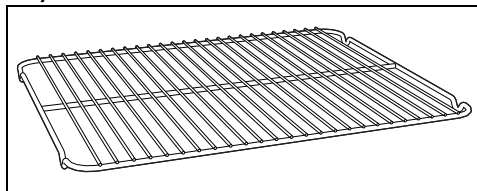

To be placed over the top of the tray; for cooking foods which may drip.

### Funnel

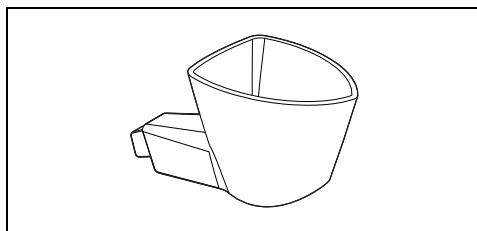

Used for filling the reservoir with water.

### Advantages of assisted steam cooking

The assisted steaming cooking system cooks any type of food much smoother and faster and finds its main applications for:

- Braising and stewing
- Cooking sauces
- Cooking au gratin
- Roasting
- Low temperature cooking
- Regenerating
- Multi-mode cooking

Variations in temperature and humidity levels allow the wished gastronomic result to be achieved.

The addition of steam allows the use of less fat in favour of a healthier and more genuine cuisine. It also minimizes the loss of weight and volume in food while cooking.

Assisted steam cooking is particularly suitable for cooking meat: in addition to making it very soft, it maintains it bright and makes it more succulent.

Also recommended for baking leavened and bread dough. The humidity in fact lets the dough grow and develop while cooking before creating the outer crust. The result is a lighter and more digestible mixture, recognizable by thicker

# USE

## Preliminary operations



See General safety instructions.

- Remove any protective film from the outside or inside of the appliance, including accessories.
- Remove any labels (apart from the technical data plate) from the accessories and shelves.
- Remove and wash all the appliance accessories (see chapter "CLEANING AND MAINTENANCE").

### First heating

1. Set a cooking time of at least one hour (see paragraph "Using the oven").
2. Heat the empty oven compartment at the maximum temperature to burn off any residues left by the manufacturing process.

When heating the appliance

- air the room;
- don't stay.

## Using the accessories

### Racks and trays

Racks and trays have to be inserted into the side guides until they come to a complete stop.

- The mechanical safety locks that prevent the rack from being removed accidentally must face downwards and towards the back of the oven cavity.

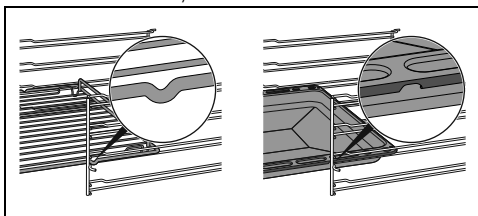

Gently insert racks and trays into the oven until they come to a stop.



Clean the trays before using them for the first time to remove any residues left by the manufacturing process.

### Tray rack

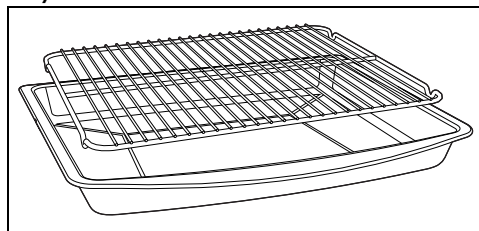

The tray rack has to be inserted into the tray. In this way, fat can be collected separately from the food which is being cooked.

### Digital programmer

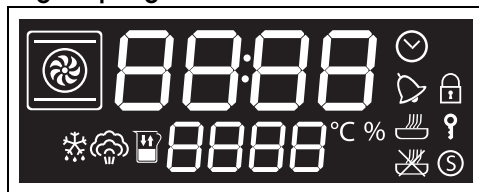

The parameters and values for the currently selected function will be indicated on the display. To use it, just turn the function and temperature knobs to select the indicated values.



Clock indicator light



Minute minder indicator light



Cooking indicator light



Programmed cooking indicator light



Door lock indicator light (pyrolytic models only)



Control lock indicator light



Showroom indicator light



Defrost indicator light



Steam indicator light



Reservoir drain indicator light



Temperature indicator light



Steam percentage indicator light

## First use



If the time is not set, the oven will not switch on.

When using the appliance for the first time or after a prolonged power failure, **00:00** will flash on the display. In order to start a cooking function, the current time has to be set.

1. Turn the temperature knob to select the current time.
2. Press the temperature knob to set the hours and then move to the minutes.
3. Turn the temperature knob to select the minutes.
4. Press the temperature knob to finish adjustment.







It may be necessary to change the current time, for example for daylight saving time.



When the current time is shown, the display will be dimmed 2 minutes after the knobs were last used.

## How to interpret symbols in steam-assisted functions

When a function with steam-assisted (cooking, special or cleaning) is selected, the appliance uses the following rules:

1. On the display, the indicator light  flashes as a reminder to check the actual presence of water (or detergent) inside the reservoir.
2. On the control panel:
  - the indicator lights are off : the reservoir is empty;
  - only one indicator light is on : the reservoir contains at least a minimum amount of water or detergent;
  - both indicator lights are on : the reservoir is full.



For functions (cooking, special or cleaning) that use steam-assisted, it is always necessary to press the function knob to start them.

## Using the oven



See General safety instructions.

## Traditional cooking



Cooking functions can be interrupted at any time by turning the function knob to the 0 position.

1. Turn the function knob to the right or to the left to select the wished function (for example "FAN-ASSISTED" ).
2. Turn the temperature knob to the right or to the left to select the wished temperature (for example "200°C").

Wait 3 seconds (or press the temperature knob before waiting 3 seconds) to start cooking.

After having started cooking, press the temperature knob to enter any setting of cooking duration, cooking end time...



When the door is opened, the function in progress is interrupted. The function resumes automatically when the door is closed.



## Preheating stage

Cooking itself is preceded by a preheating stage, which allows the appliance to heat to the cooking temperature more quickly.

The indicator light  flashes to indicate that this stage is in progress.



You can skip the preheating phase by pressing the temperature knob for a few seconds.

At the end of preheating the indicator light  will stay on permanently, the symbol of the oven cavity  flashes and a buzzer sounds.

1. Open the door

- Place the dish with the food to be cooked into the oven cavity.
- Close the door.

or

If the dish with the food is already inside the oven cavity, press the temperature knob to start cooking.

### Timed cooking



Timed cooking is the function which allows a cooking operation to be started and then ended after a specific length of time set by the user.



Activation of timed cooking cancels any minute minder timer which may previously have been set.

- After selecting a cooking function and temperature, press the temperature knob.

The display shows **00:00** flashing.



- Within 3 seconds turn the temperature knob to change the temperature or
- Press the temperature knob to set the cooking time (from 1 minute to 13 hours) (e.g. "25 minutes").



- Wait 3 seconds.

The indicator light  stops flashing, the symbol  lights up and timed cooking begins.

At the end of the cooking time **STOP** flashes on the display and a buzzer will sound that can be deactivated by opening the door

and/or pressing/turning any of the two knobs.



To select a further timed cooking, turn again the temperature knob.

### To delete a timed cooking

- Press the temperature knob.

The indicator light  flashes on the display.

- Within 3 seconds, turn the temperature knob counter-clockwise until the cooking time is reset.
- Wait 3 seconds or press the temperature knob to exit the timed cooking function and return to the current time display.

### Programmed cooking



Programmed cooking is the function which allows a cooking operation to be started at a set time and then ended after a specific length of time set by the user.



For safety reasons, it is not possible to set the end of cooking time by itself without setting the cooking duration.

- After selecting a cooking function and temperature, press the temperature knob.

The display shows **00:00** flashing.



- Within 3 seconds turn the temperature knob to set the cooking time (from 1 minute to 13 hours) (e.g. "25 minutes").



3. Press the temperature knob.  
The display shows the suggested flashing time for immediate cooking.

 In case of confirmation without modification, cooking starts immediately. If time is added to the suggested time, cooking stops

4. Turn the temperature knob within 3 seconds to set the end of cooking time (e.g. "13:15").



5. Wait 3 seconds.

The indicator light  and the appliance waits for the set start time.



 The minutes required for preheating are already included in the end-of-cooking time.

At the end of the cooking time **STOP** flashes on the display and a buzzer will sound that can be deactivated by opening the door and/or pressing/turning any of the two knobs.



### To delete a programmed cooking

1. Press the temperature knob.

The indicator light  flashes on the display.

2. Within 3 seconds, turn the temperature knob clockwise or counter-clockwise to set a new timed cooking.

The set cooking has now been deleted.

 Cooking functions can be interrupted at any time by turning the function knob to the 0 position.

### Minute minder timer during a cooking process

 The minute minder timer does not stop the cooking operation but rather informs the user when the set time has run out.

 It is not possible to set a minute minder during a cooking if a timed cooking has already been set.

1. After selecting a cooking function and temperature, press the temperature knob two times.

The display shows **00:00** and the indicator light  flashes.



 You can also set a minute minder timer also when cooking is in progress.

2. Within 3 seconds turn the temperature knob to set the duration of the minute minder (from 1 minute to 13 hours).

3. Wait 3 seconds.

The indicator light  stops flashing and the minute minder starts.

4. Wait for the buzzer to indicate that the time has finished.

The digits **00:00** and the indicator light  flash.

5. Turn the temperature knob to select additional minute minders or press the temperature knob to deactivate the buzzer and exit the minute minder during cooking.

After a few seconds, the display shows the current time and the cooking in progress continues.

## To delete a minute minder timer during cooking

1. During cooking, press the temperature knob twice.

The indicator light  flashes on the display.

2. Within 3 seconds, turn the temperature knob counter-clockwise until the minute minder value is reset.
3. Wait 3 seconds to exit the minute minder function during cooking.

## List of traditional cooking functions



Not all functions are available on some models.

### STATIC



Traditional cooking, ideal for preparing a single dish. For example cooking roast meats, fatty meats, bread, pies.

### FAN ASSISTED



Intense and uniform cooking. Ideal for biscuits, cakes and cooking on more than one level.

### CIRCULAIRE



The heat is distributed quickly and uniformly. Suitable for all dishes, ideal for cooking on multiple levels without mixing smells or flavours.

### GRILL



Produces excellent grilling and gratinating results. When used at the end of cooking, gives a uniform browning to dishes.

### FAN WITH GRILL



Allows optimal grilling, even for thick slices of meat. Perfect for larger cuts of meat.

### BOTTOM HEAT



The heat comes from the bottom of the cavity. Perfect for cakes, pies, tarts and pizzas.

### THERMALLY-VENTILATED BASE



Allows you to quickly finish cooking food already cooked on the surface but not internally. Perfect for any quiches and any type of food.

## ECO



This function is particularly suitable for cooking on a single shelf with low energy consumption.

It is recommended for all types of food except those that may produce a large amount of moisture (e.g. vegetables). To obtain maximum energy savings and reduce cooking times, it is recommended to place food in the oven without preheating.



When using the ECO function, avoid opening the door during cooking.



Cooking (and preheating) times are longer with the ECO function and may depend on the amount of food in the oven.



The ECO function is a delicate cooking function and is recommended for cooking that does not require temperatures higher than 210°C. It is recommended that you select a different function for cooking at higher temperatures.

## Steam-assisted cooking

### Reservoir filling

1. Turn the function knob to the steam-assisted

function  +  to display the level indicators      .

2. Open the door and pull the loading drawer out of its housing.

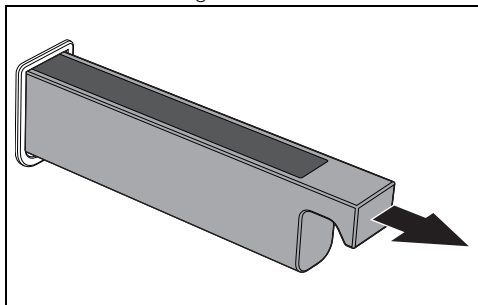

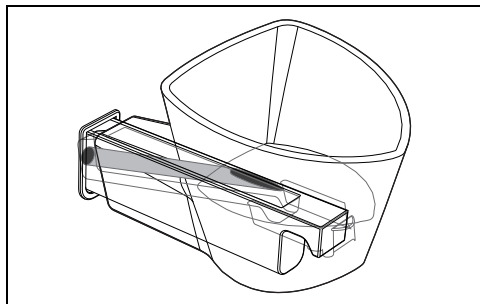

- Insert the funnel provided in the loading drawer.

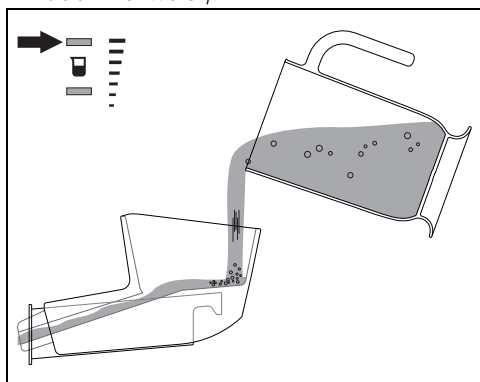

- Pour the water (using a bottle or a measuring jug) until the max. level indicator light comes on (the reservoir contains about 800 ml of water).



 Use cold tap water which is not too hard, softened water or still mineral water.

 Do not use distilled water, tap water with a high chloride content (> 40 mg/l), or other liquids.

- At the end, remove the funnel and place the loading drawer back in its place.

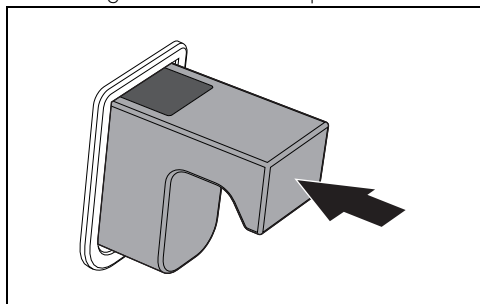

If there is too much water in the reservoir, the



excess water will drain into the cooking compartment:

- in this case dry with a cloth or sponge before a cooking.
  - It is recommended to drain the 200 ml reservoir through the reservoir drain function.
- Close the door.



### Steam-assisted cooking (quick start)

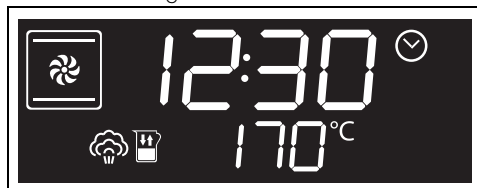

Cooking functions can be interrupted at any time by turning the function knob to the 0 position.

- Select the steam-assisted function using the function knob.  + 





- While the indicator lights  +  +  flash, press the temperature knob again to start steam-assisted cooking.



Quick start is set to the steam-assisted percentage  40%.

### Steam-assisted cooking

- Select the steam-assisted function using the function knob.  + 
- Turn the temperature knob to set the cooking temperature (from 100°C to 250°C) (for example "190°C").



- While the indicator light  is flashing, press the temperature knob.



- Turn the temperature knob to set the possible cooking time (from 1 minute to 13 hours) (e.g. "35 minutes").





 Activation of timed cooking cancels any minute minder timer which may previously have been set.



- While the indicator light  is flashing, press the temperature knob.
- Turn the temperature knob to set the type of steam-assisted cooking (40% or 20%).





 Steam-assisted function  40%: particularly suitable for cooking fish and meat with a high fat content: the steam dissolves them keeping the food soft, making it more digestible and well browned on the surface.

 Steam-assisted function  20%: it is recommended to use steam-assisted cooking only for the first 5 - 10 minutes, then switch to the corresponding function without steam  to complete the cooking. This function is also indicated for the preparation of products breaded with egg and breadcrumbs, as it restores crunchiness to the breadcrumb coat, thus simulating the result of frying, but more digestible.

- Press the temperature knob.

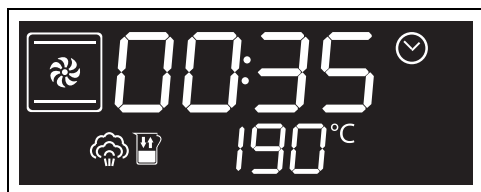
- While the indicator lights  +  +  flash, press the temperature knob again to start the function.



 When the door is opened, the function in progress is interrupted. The function resumes automatically when the door is closed.

### Reservoir draining

 Before draining the reservoir, wait for the oven to cool down, leaving the door open. To make sure that the water remaining in the reservoir is not too hot, wait at least 40 minutes.

After cooking:

- Open the door
- Place the deep tray on the third shelf from the bottom. Push it against the rear wall of the oven cavity.
- After entering the special functions menu, turn the temperature knob until the Reservoir drain function is selected.



- Press the temperature knob to confirm the function.
- Press the temperature knob again to start the function.

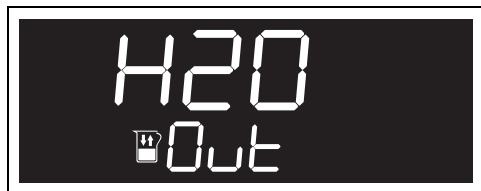



The water starts to flow into the deep pan from the drain pipe on the right side of the rear wall

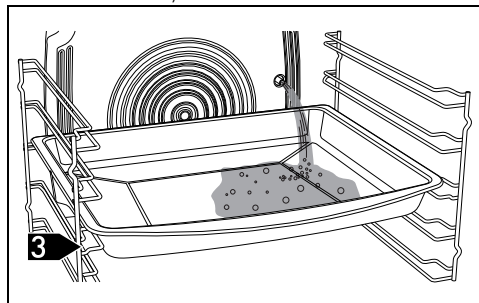

of the oven cavity.





6. Wait for the end of the exhaust flow (check that both level indicator lights   are switched off).
7. At the end, return the function knob to the 0 position.

 It is recommended to drain at the end of each cooking, to prevent any residue of unused water from remaining inside the reservoir.

 After a long period of inactivity it is recommended to make a reservoir filling and draining cycle to rinse the steam circuit.

8. Drain the water from the deep pan.

 Take care: the water may be very hot.

 The drained water cannot be used for other cooking.

### Drying after steam functions

Cooking with steam generates a lot of moisture inside the appliance. This is a normal phenomenon and does not affect the appliance's operation in any way.

Each time you finish cooking:

1. let the appliance cool down;
2. thoroughly dry the oven cavity and the accessories used with a soft cloth or paper towels;
3. leave the door open until the inside of the appliance has dried completely.

## List of steam assisted cooking functions



Assisted-steam cooking at 40%: the steam is delivered constantly throughout the cooking time and is recommended for long cooking of meat, fish, timbales, tarts, lasagna, etc... Particularly suitable for cooking fish and meat with a high fat content. The steam melts them while keeping the food soft, making it more digestible and nicely browned on the surface.



Assisted steam function at 20%: the steam is delivered in small pulses. It is recommended for baking cakes and bread-type products (bread, focaccia, etc...) where the amount of steam must be minimal to allow the food to lose its moisture and cook internally. The steam facilitates leavening during the first few minutes of baking, creating a shiny, crisp surface.

Steam-assisted cooking is recommended only for the first 5-10 minutes, then switch to the corresponding function without steam to complete cooking.

This function is also indicated for the preparation of products breaded with egg and breadcrumbs, as it restores crunchiness to the breadcrumb coat, thus simulating the result of frying, but more digestible.

### 20% STEAM-ASSISTED



the steam is delivered in small pulses. It is recommended for baking cakes and bread-type products (bread, focaccia, etc...) where the amount of steam must be minimal to allow the food to lose its moisture and cook internally. The steam facilitates leavening during the first few minutes of baking, creating a shiny, crisp surface.

### 40% STEAM-ASSISTED



the steam is delivered constantly throughout the cooking time and is recommended for long cooking of meat, fish, timbales, tarts, lasagna, etc...

# Cooking advice

## General advice

- Use a fan-assisted function to achieve consistent cooking at several levels.
- It is not possible to shorten cooking times by increasing the temperature (the food could be overcooked on the outside and undercooked on the inside).

## Advice for cooking meat

- Cooking times vary according to the thickness and quality of the food and to consumer taste.
- Turn the food to brown both sides.
- Use a meat thermometer when roasting meat, or simply press on the roast with a spoon. If it is hard, it is ready; If not, it needs another few minutes cooking.

## Advice for cooking with the Grill

- Meat can be grilled even when it is put into the cold oven or into the preheated oven if you wish to change the effect of the cooking.
- When using the fan-assisted with grill function (if any), we recommend that you preheat the oven before grilling.
- We recommend placing the food at the centre of the rack.
- With the Grill function, we recommend that you set the temperature to the maximum value to optimise cooking.

## Advice for cooking desserts/pastries and biscuits

- Use dark metal moulds: They help to absorb the heat better.
- The temperature and the cooking time depend on the quality and consistency of the dough.
- To check whether the dessert is cooked right through: At the end of the cooking time, put a toothpick into the highest point of the dessert. If the dough does not stick to the toothpick, the dessert is cooked.
- If the dessert collapses when it comes out of the oven, on the next occasion reduce the set temperature by about 10°C, selecting a longer cooking time if necessary.

## Advice for cooking with two shelves:

- We suggest to arrange two racks (they can be requested to Authorised Service Centres).
- To facilitate the air flow, place the moulds/

casseroles in the centre of the racks and make sure that their width/diameter does not exceed 30 cm.

- Place the racks leaving one free shelf between them.
- Depending on the food and the increased load inside the cavity, cooking on two levels may take a few minutes longer than on a single shelf.
- The functions indicated for cooking on two shelves are THERMALLY-VENTILATED and THERMALLY-VENTILATED BASE.

## Advice for steam cooking

- For bread-type products (bread, focaccia, etc.) and frozen desserts, where steam is useful during the first few minutes of cooking, we recommend setting a steam function for the first 5-10 minutes and then switching to ventilated mode to complete cooking.
- For steam heating insert in a cold oven.

## Advice for defrosting and proving

- Place frozen foods without their packaging in a lidless container on the first shelf of the oven.
- Avoid overlapping the food.
- To defrost meat, use the rack placed on the second level and a tray on the first level. In this way, the liquid from the defrosting food drains away from the food.
- The most delicate parts can be covered with aluminium foil.
- For successful proving, a container of water should be placed in the bottom of the oven.

## To save energy

- Stop cooking a few minutes before the time normally used. Cooking will continue for the remaining minutes with the heat which has accumulated inside the oven.
- Reduce any opening of the door to a minimum to avoid heat dispersal.
- Keep the inside of the appliance clean at all times.

## Mini guide to accessories

EN



Rack

We recommend the use of the grill as a support surface for baking moulds/casseroles.

In the absence of the baking tray grill, the grill can be used as a base for grilling with the deep baking tray placed on a shelf below to collect the juices.

For multilevel baking, place two grills leaving one free shelf between them. Use the

THERMALLY-VENTILATED



and/or THERMALLY-VENTILATED BASE function



We recommend the use of the deep baking tray for cooking on one level only.

Place the deep baking tray on the centre shelf when using the fan-assisted functions. When



Deep tray

using the STATIC function,



place the deep baking tray on the required shelf.

Place the baking tray on the last shelf with the baking tray grill to cook in GRILL mode



Tray rack

We recommend using the baking tray grill as a base to collect the juices from the grills.

## Discover the recipes

To consult the recipes developed for various categories of food and to get more information on cooking suggestions, we recommend visiting the dedicated page on the [www.smeg.com](http://www.smeg.com) website, which can be reached using the QR code on the leaflet supplied with the product.

## Information for Supervisory Bodies

### Fan forced mode

The ECO function used to establish the energy efficiency class is compliant with the specifications of European standard EN 60350-1.

See the "To save energy " section in the INSTRUCTIONS chapter.

### Conventional heating mode

To use the STATIC mode, you have to skip the preheating stage (see the section "Preheating stage" in the USE chapter).

See the "To save energy " section in the INSTRUCTIONS chapter.

### Minute minder



This function only operates the buzzer at the end of the countdown.

1. With the Function Knob at position 0, press the temperature knob.

The display shows  and the indicator

light  flashes.

2. Within 3 seconds turn the temperature knob to set the duration of the minute minder (from 1 minute to 13 hours).
3. Wait 3 seconds.

The indicator light  stops flashing and the minute minder starts.



During the function, the display shifts to low brightness after 2 minutes from the last knob operation.

### End of the minute minder

1. Wait for the buzzer to indicate that the time has finished.

The digits  and the indicator light  flash.

2. Turn the temperature knob to select another minute minder.
- or
3. Press the temperature knob to deactivate the buzzer and exit the minute minder function.

After a few seconds, the display shows the current time.

### To delete a minute minder

1. Press the temperature knob.

The indicator light  flashes on the display.

2. Within 3 seconds, turn the temperature knob counter-clockwise until the minute minder value is reset.

- Wait 3 seconds to exit the minute minder function.

## Special functions

- Turn the function knob until the following text is displayed.



- Press the display knob to enter the special functions menu.

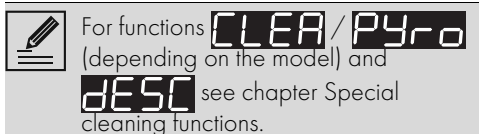

## Steam-assisted defrost

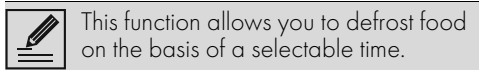

- Place the food to be defrosted inside the oven.
- After entering the special functions menu, turn the temperature knob until the Steam-assisted defrost is selected.



- Press the temperature knob to confirm the function.

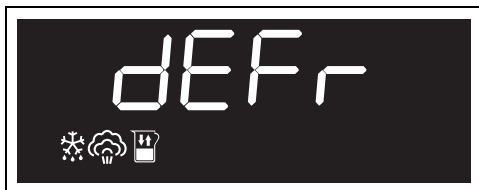

- Proceed with filling the reservoir with water as described in section 2 of the chapter "Filling the reservoir".

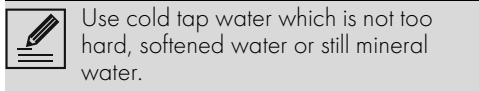

- When the reservoir has been loaded, press the temperature knob to start setting the defrosting parameters.

The display shows **00:00** and the indicator lights and flashes.



- Turn the temperature knob to set the defrosting time (from 1 minute to 13 hours) (e.g. "1:30").
- Wait 3 seconds or press the temperature knob to start the function.



At the end, the flashing wording **STOP** is displayed and a buzzer will sound that can be deactivated by opening the door and/or pressing/turning any of the two knobs.

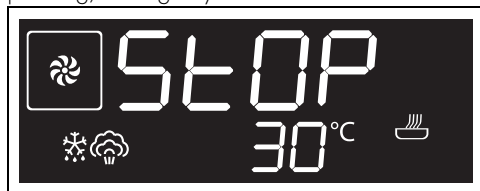

- At the end, proceed with draining the water from the reservoir into the tray on the third shelf as described in the chapter "Draining the reservoir".
- Wait until it ends flowing.
- Turn the function knob to position 0 to exit the function.

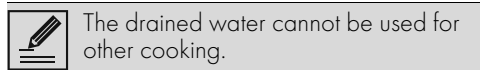

- Drain the water from the deep pan.

## Proving



For successful proving, a container of water should be placed in the bottom of the oven.

1. Position the dough to prove on the second level.
2. After entering the special functions menu, turn the temperature knob until the Proving function is selected.



3. Press the temperature knob to confirm the function.
4. Wait 3 seconds to start the function or press the temperature knob to enter any setting of function duration, function end time...



5. At the end, turn the function knob to position 0 to exit the function.

## Sabbath mode



This function results in the appliance operating in a particular way:

- Cooking can proceed for max. 73 hours, it is not possible to set any cooking duration.
- No pre-heating will be performed.
- The cooking temperature which can be selected varies between 60-150 °C.
- Oven light disabled, any operation such as opening the door (where present) or manual activation with the knob will not activate the light.
- The internal fan remains turned off.
- Knob illumination and audible prompts remain disabled.



After activating the Sabbath mode the settings cannot be altered.

Any action on the knobs will produce no effect; only the function knob remains active to allow you to return to 0 and switch the function off.

1. Place the dish into the oven cavity.
2. After entering the special functions menu, turn the temperature knob until the Sabbath mode is selected.



3. Press the temperature knob to confirm the function.

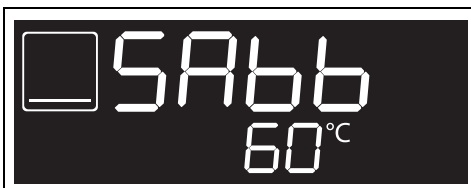

4. Turn the temperature knob to set required temperature (for example "90°C").
5. Press the temperature knob to start the function.

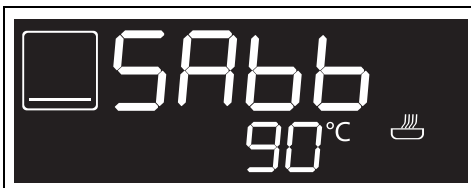

6. When finished, turn the function knob to position 0 to end cooking.

## PIZZA



Function designed for cooking pizza. Perfect not just for pizzas, but also for biscuits and cakes.

1. After entering the special functions menu, turn the temperature knob until the PIZZA function is selected.





2. Press the temperature knob to confirm the function.
3. Wait 3 seconds to start the function or press the temperature knob to enter any setting of temperature, cooking duration, cooking end time...



Cooking itself is preceded by a preheating stage, which allows the appliance to heat to the cooking temperature more quickly.

The indicator light  flashes to indicate that this stage is in progress.

When the preheating stage is over, the indicator light  will remain lit steadily and a buzzer sounds to indicate that the food can be placed inside the oven cavity.

 In this function it is not possible to skip the preheating phase.

At the end of the cooking time **STOP** flashes on the display and a buzzer will sound that can be deactivated by opening the door and/or pressing/turning any of the two knobs. To continue with the cooking of other pizzas, after deactivating the buzzer:

- press the function knob again to start the function
  - or
  - turn the function knob to set a new cooking time and restart the function.
4. Turn the function knob to position 0 to exit the function.

## TURBO



Allows rapid cooking on multiple levels without mixing aromas. Ideal for large volumes of food or intense cooking.

1. After having accessed the special functions menu, turn the temperature knob to select the TURBO function.

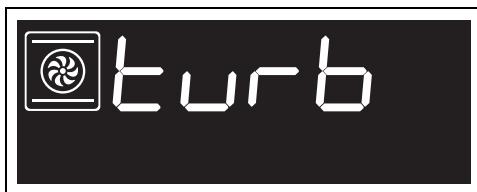



2. Press the temperature knob to confirm the function.
3. Wait 3 seconds before starting the function or press the temperature knob to enter the settings for temperature, cooking duration, end of cooking time etc.



Cooking itself is preceded by a preheating stage, which allows the appliance to heat to the cooking temperature more quickly.

The indicator light  flashes to indicate that this stage is in progress.

When the preheating stage is over, the indicator light  will remain lit steadily and a buzzer will sound to indicate that the food can be placed in the oven.

 The preheating stage can be skipped by pressing the temperature knob for a few seconds.

At the end of cooking, **STOP** flashes on the display and a buzzer will sound that can be deactivated by opening the door or pressing/turning one of the two knobs.

4. Turn the function knob to 0 to exit from the function.

## Reservoir draining



This procedure is useful for draining water or detergent from the hydraulic circuit.

5. Open the door
6. Place the deep tray on the third shelf from the bottom. Push it against the rear wall of the oven cavity.
7. After entering the special functions menu, turn the temperature knob until the Reservoir drain function is selected.



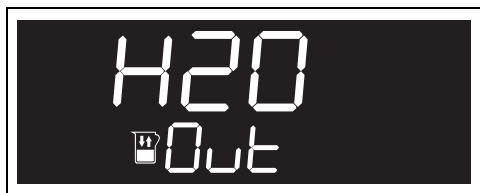

8. Press the temperature knob to confirm the function.
9. Press the temperature knob again to start the function.

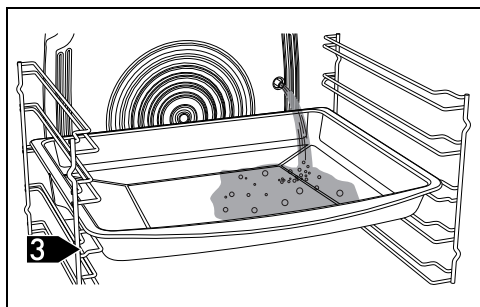

The water (or detergent) starts flowing out of the drain pipe, located on the right side of the deflector.



10. Wait for the end of the exhaust flow (check that both level indicator lights   are switched off).

11. Press the temperature knob to stop the drain function.



You can interrupt/resume the drain flow by pressing the function knob.

12. Return the function knob to the 0 position.
13. Drain the water (detergent) from the deep tray.

## Settings

1. Turn the function knob until the following text appears on the display.





2. Press the temperature knob to access the settings menu.

## Current time

After entering the settings menu, turn the temperature knob until the current time function is selected.



1. Press temperature knob to start adjusting the current time (e.g. "12:30").

During this procedure, the indicator light  and the symbols  flash.



2. Turn the temperature knob to select the current time.



- Press the temperature knob to set the current time and go to the selection of minutes.



- Turn the temperature knob to select the minutes of the current time.



- Press the temperature knob to finish adjustment.



- Turn the temperature knob to select a new setting or wait 10 seconds.

### Control lock (children safety)

 This mode allows the appliance to lock the controls automatically after one minute of normal operation without any intervention from the user.

- After entering the settings menu, turn the temperature knob until the control lock function is selected.





- Press the temperature knob to confirm.

The indicator light  flashes.

- Within 10 seconds turn the temperature knob to activate the control lock function.



- Press the temperature knob to confirm.
- Turn the display knob to select a new setting.

 In normal operation, the control lock is indicated by the  indicator light coming on.

 Touching or varying the position of the knobs, the display will show the wording **bLOC** for two seconds.

 To release the lock temporarily during cooking, hold the temperature knob down for 5 seconds. One minute after the last setting the lock will become active again.

### Showroom (for showrooms only)

 This mode allows the appliance to deactivate all heating elements, while keeping the control panel active.

- After entering the settings menu, turn the temperature knob until the showroom function is selected.





- Press the temperature knob to confirm.
- Turn the temperature knob to activate the showroom function.





- Press the temperature knob to confirm or wait 10 seconds.

 The activated showroom is indicated on the display by the  indicator light on.

 To use the appliance normally, set this function to OFF.

### Keep warm

 This mode allows the appliance after cooking finishes with a cooking cycle for which a duration has been set (if this is not manually interrupted), to keep cooked food warm (at low temperatures) without altering the taste and aromas obtained during cooking.

- After entering the settings menu, turn the temperature knob until the keep warm function is selected.

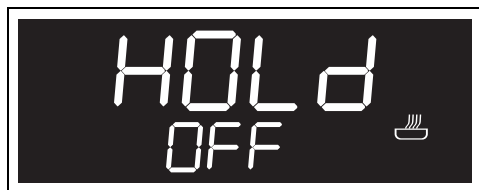

- Press the temperature knob to confirm.
- Turn the temperature knob to activate the keep warm function.

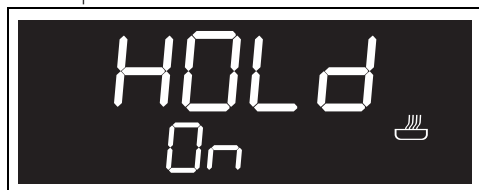

- Press the temperature knob to confirm.

 To use the appliance normally, set this function to OFF.

### Water hardness

 This mode allows you to set the water hardness value in order to optimise the descaling process.

 The appliance is factory set for water of medium hardness (3).

- After entering the settings menu, turn the temperature knob until the Water hardness function is selected.

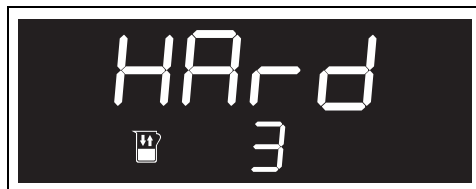

- Press the temperature knob to confirm.
- Turn the temperature knob to set the water hardness (values from 1 to 5) (e.g. "2").

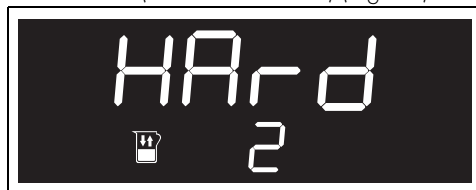

- Press the temperature knob to confirm.
- Turn the display knob to select a new setting.

 If your mains water supply is too hard, we recommend using a water softener.

 Request information on the hardness of your water from your local water board.

Depending on the degree of water hardness (°dH or °dF), the number of hours after which descaling is required is as follows:

Value	°dH	°dF	Hours
1	0 - 11	0 - 20	50
2	12 - 17	21 - 30	45
3	18 - 24	31 - 42	35
4	25 - 30	43 - 53	25
5	31 - 50	54 - 90	10

# CLEANING AND MAINTENANCE

## Cleaning the appliance



See General safety instructions.

### Cleaning the surfaces

To keep the surfaces in good condition, they should be cleaned regularly after use. Let them cool first.

### Ordinary daily cleaning

Always and only use specific products that do not contain abrasives or chlorine-based acids. Pour the product onto a damp cloth and wipe the surface, rinse thoroughly and dry with a soft cloth or a microfibre cloth.

### Food stains or residues

Do not use steel sponges and sharp scrapers as they will damage the surface.

Use normal, non-abrasive products and a wooden or plastic tool, if necessary. Rinse thoroughly and dry with a soft cloth or a microfibre cloth.

Do not allow residues of sugary foods (such as jam) to set inside the oven. If left to set for too long, they might damage the enamel lining of the oven.

## Cleaning the door

### Door disassembly

For easier cleaning it is recommended to remove the door and place it on a tea towel.

To remove the door proceed as follows:

1. Open the door completely and insert two pins into the holes on the hinges indicated in the figure.

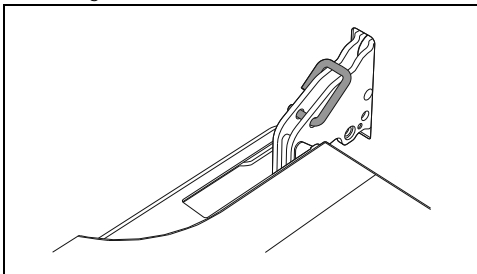

2. Grasp the door on both sides with both hands, lift it forming an angle of around 30° and remove it.

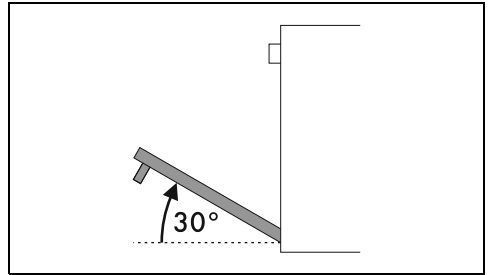

3. To reassemble the door, put the hinges in the relevant slots in the oven, making sure that grooved sections **A** are resting completely in the slots.

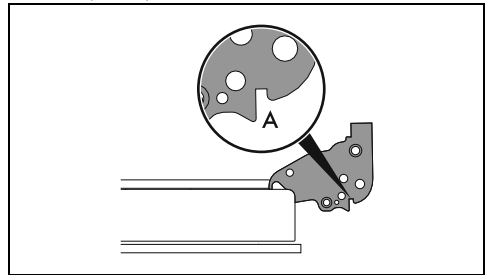

4. Lower the door and once it is in place remove the pins from the holes in the hinges.

### Cleaning the door glazing

The glass in the door should always be kept thoroughly clean. Use absorbent kitchen roll. In case of stubborn dirt, wash with a damp sponge and an ordinary detergent.

### Removing the internal glass panes

For easier cleaning the internal glass panes of the door can be removed.

1. Lock the door with the appropriate pins.
2. Remove the internal glass pane by pulling the rear part gently upwards, following the movement indicated by the arrows 1.

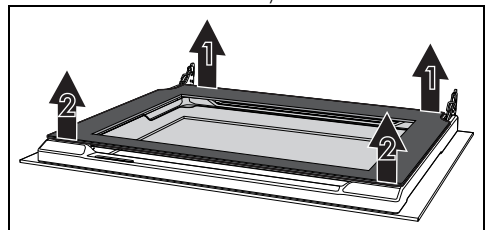

3. Release the front pins following the movement indicated by the arrows 2
4. Then remove the inner glass pane from the front profile.

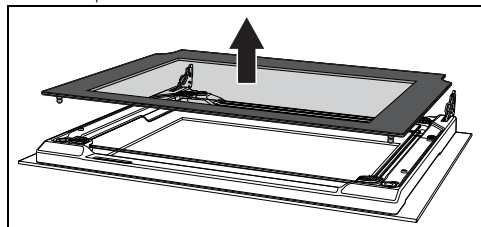

5. Pull the intermediate glass unit downwards from the door and then lift it upwards.

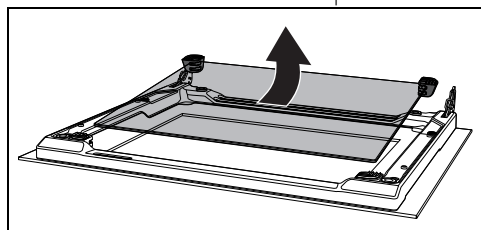

Note: In some models, the intermediate glass unit consists of two panes.

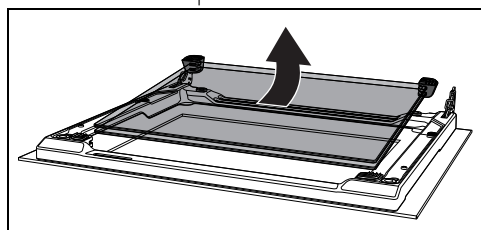

During this step, the upper grommets may come out of their seats.

6. Insert the front grommets into their seats. The feet of the grommets must be facing the outer glass

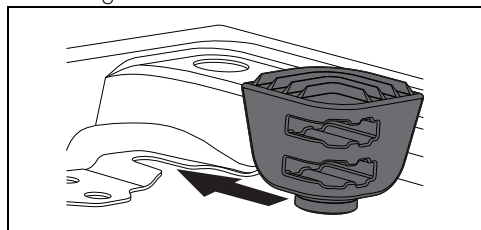

7. Clean the external glass pane and the panes removed previously.

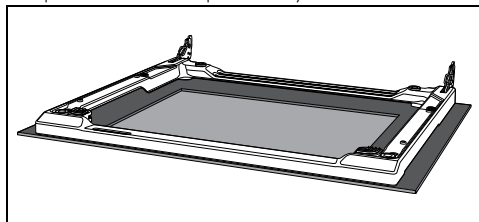

8. Use absorbent kitchen roll. In case of stubborn dirt, wash with a damp sponge and neutral detergent.
9. Reinsert the intermediate glass unit and reposition the inner glass.

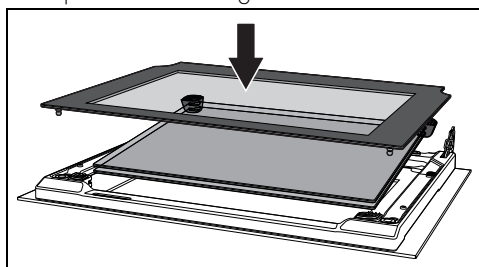

The intermediate glass pane must be repositioned on the open door so that the screen printing in the corner can be read from left to right (the rough part of the screen printing must face the external glass pane of the door).



10. Be sure to fit the 4 pins of the inner glass well into their seats on the door.

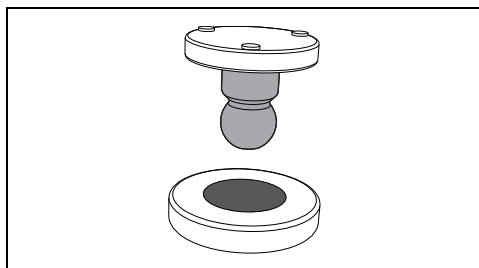

### Cleaning the oven cavity

In order to keep your oven in the best possible condition, clean it regularly after letting it cool

down.

Avoid letting food residue dry inside the oven cavity, as this could damage the enamel.

Take out all removable parts before cleaning. For easier cleaning, it is recommended to remove:

- the door;
- The rack/tray support frames.



In the event you are using specific cleaning products, we recommend running the oven at maximum temperature for 15-20 minutes in order to eliminate any residue.

## Drying

Cooking food generates moisture inside the appliance. This is a normal phenomenon and does not affect the appliance's operation in any way.

Each time you finish cooking:

1. Let the appliance cool down.
2. Remove any dirt from inside the appliance.
3. Dry the interior of the appliance with a soft cloth.
4. Leave the door open until the inside of the appliance has dried completely.

## Removing racks/trays support frames

Removing the rack/tray support frames enables the sides to be cleaned more easily.

To remove the rack/tray support frames:

- Pull the frame towards the inside of the oven cavity to unhook it from its groove A, then slide it out of the seats B at the back.

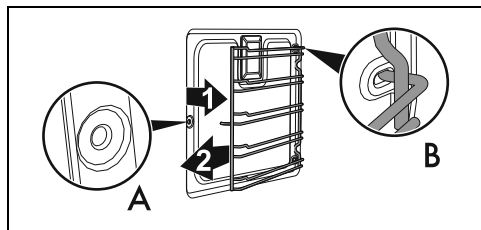

- When cleaning is complete, repeat the above procedures to put the rack/tray support frames back in.

## Special cleaning functions

1. Turn the function knob until the following text appears on the display.



2. Press the temperature knob to access the special functions menu.

## Vapor Clean (on some models only)



See General safety instructions.



The Vapor Clean function is an assisted cleaning procedure that facilitates the removal of dirt. Thanks to this process, it is possible to clean the inside of the oven very easily. The dirt residues are softened by the heat and water vapour for easier removal afterwards.

## Preliminary operations

Before starting the Vapor Clean cycle:

- Completely remove all accessories from inside the oven.
- Remove the temperature probe, if present.
- Remove the self-cleaning panels, if present.
- Pour approx. 120 cc of water onto the floor of the oven. Make sure it does not overflow out of the cavity.
- Spray a water and washing up liquid solution inside the oven using a spray nozzle. Direct the spray towards the side walls, upwards, downwards and towards the deflector.



We recommend spraying approx. 20 times at the most.



Do not spray the deflector if it has a self-cleaning coating.

- Close the door.
- During the assisted cleaning cycle, wash the self-cleaning panels (where fitted), which were previously removed, separately in warm water and a small amount of detergent.

## Vapor Clean cycle setting



If the internal temperature is greater than the one required, the function will be stopped immediately and the following message appears on the display:



Let the appliance cool down before activating the function.

3. After having accessed the special functions menu, turn the temperature knob to select the Vapor Clean function.



4. Press the temperature knob to confirm the function.



The duration and temperature parameters cannot be changed by the user.

5. Wait 3 seconds before starting the function.



6. At the end of the Vapor Clean cycle, **STOP** appears on the display and a buzzer will sound that can be deactivated

by opening the door or pressing/turning one of the two knobs.



7. Turn the function knob to 0 to exit from the function.

## Programmed Vapor Clean cycle

It is possible to program the Vapor Clean function start time, like all other cooking functions.

1. After having selected the Vapor Clean function, turn the temperature knob (the indicator light  comes on) to set the time at which you want the Vapor Clean function to end.
2. Wait 3 seconds before confirming the settings.

The appliance waits until the set start time to start the Vapor Clean function.

## Vapor Clean End

1. Turn the function knob to 0 to exit from the function.
2. Open the door and wipe away the less stubborn dirt with a microfibre cloth.
3. Use a non-scratch sponge with brass filaments on hard to remove deposits.
4. In case of grease residues use specific oven cleaning products.
5. Remove the residual water inside the oven.
6. Replace the self-cleaning panels and the rack/tray support frames, if fitted.

For greater hygiene and to avoid foods taking on unpleasant odours:

- We recommend drying the inside of the oven with a fan assisted function at 160°C for around 10 minutes.
- If self-cleaning panels are fitted, we recommend that you dry the inside of the oven with a simultaneous catalytic cycle.



We recommend wearing rubber gloves for these operations.



We recommend removing the door in order to make the manual cleaning of the parts that are difficult to reach easier.

## Pyrolytic (on some models only)



See General safety instructions.



Pyrolytic cleaning is an automatic high-temperature cleaning procedure which causes dirt to dissolve. This process makes it possible to clean the inside of the oven very easily.

## Preliminary operations

Before starting the pyrolytic cycle:

- Clean the internal glass pane following the usual cleaning instructions.
- Remove any food residues or large spills from previous cooking operations from the inside of the oven.
- Completely remove all accessories from inside the oven.
- For very stubborn encrustations spray an oven cleaning product onto the glass (read the warnings on the product); leave for 60 minutes, then rinse and dry the glass using kitchen roll or a microfibre cloth.
- If present, remove the temperature probe.
- Remove the rack/tray support frames.
- Close the door.

## Pyrolytic function setting

1. After entering the special functions menu, turn the temperature knob until the Pyrolytic function is selected.



2. Press the temperature knob to confirm the function.

The display shows the Pyrolytic cycle duration

(factory set to 2 hours).



3. Turn the temperature knob to set the duration of the Pyrolytic cycle from a minimum of 2 hours to maximum of 3 hours.



Recommended pyrolytic cycle duration:

- Little dirt: LO1 - 2:00
- Moderately dirty: LO2 - 2:30
- Very dirty: LO3 - 3:00

4. Press the temperature knob to confirm the data entered.

Wait 3 seconds to start the function.



5. Two minutes after the Pyrolytic cycle starts, the  indicator light comes on to indicate that the door is locked by a device that prevents the door from being opened.



It is not possible to select any function once the door lock device has been activated.

At the end of the Pyrolytic cycle the flashing wording **STOP** is displayed and a buzzer will sound that can be deactivated by opening the door and/or pressing/turning any of the two knobs.



The door is locked until the temperature inside the oven cavity returns to a safe level.



During the Pyrolytic cycle the fans produce a more intense level of noise due to a greater rotation speed. This is an absolutely normal operation, intended to provide more effective heat dispersal. At the end of the pyrolytic cycle, the fans will continue to operate for long enough to avoid overheating the walls of adjacent units and the front of the oven.



During the first Pyrolytic cycle, unpleasant odours may occur due to the normal evaporation of oily manufacturing substances. This is an absolutely normal phenomenon which disappears after the first pyrolytic cycle.



If the pyrolytic cycle gives unsatisfactory results at minimum duration, it is recommended to set a longer time for subsequent cleaning cycles.

### Setting of a programmed Pyrolytic cycle

It is possible to program the Pyrolytic cycle start time like all other cooking functions.

1. After selecting the Pyrolysis function, turn the temperature knob (the indicator light  lights up) to set the time at which you want the Pyrolysis function to end.
2. Wait 3 seconds to confirm the data entered. The appliance waits until the set start time to start the Pyrolytic function.



It is not possible to select any function once the door lock device has been activated. It is always possible to switch the appliance off, by turning the function knob to the 0 position.

### End of pyrolytic function

1. Turn the function knob to position 0 to exit the function.
2. Open the door and collect the residue deposited inside the oven cavity with a damp microfibre cloth.



We recommend wearing rubber gloves for these operations.



For easier manual cleaning of parts that are difficult to reach, we recommend removing the door.

## Cleaning the water circuit



The presence of scale due to lack of descaling can compromise correct operation of the appliance in the long term.

Periodically the appliance will display that the descaling procedure of the hydraulic circuit is required.

### Preliminary operations

1. Open the door
2. Place the deep pan on the third shelf from the bottom. Push it against the rear wall of the oven cavity.
3. After entering the special functions menu, turn the temperature knob until the Descaling function is selected.



4. Press the temperature knob to confirm.

The display shows a request to drain the reservoir.

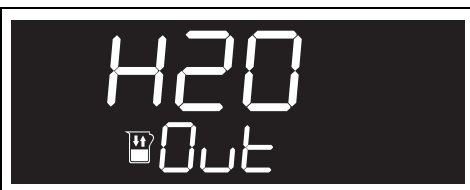

5. Press the temperature knob again to start the function.

The water (or detergent) starts to flow into the deep pan from the drain pipe on the right side of the rear wall of the oven cavity.

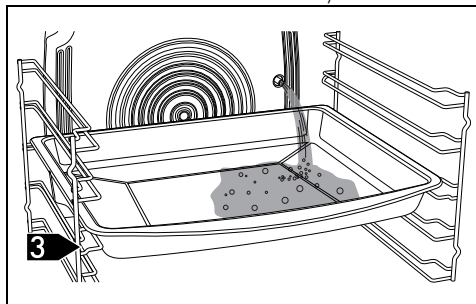

- Wait for the end of the exhaust flow (check that both level indicator lights  are switched off).
- Press the temperature knob to stop the drain function.

The display shows the request to fill the reservoir.



From now on, it will no longer be possible to cancel the descaling process.

- Drain the water (detergent) from the deep tray.

### Reservoir filling

- Mix 100 g of citric acid with 650 ml of water in a jug.



Do not use lactic acid or other descaling agents.

- Open the door and pull the loading drawer out of its housing.

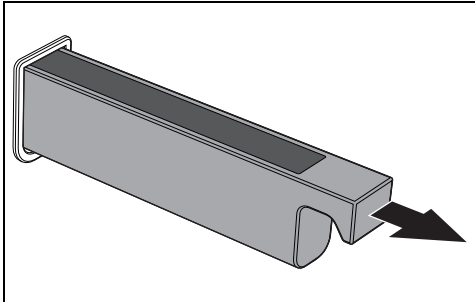

- Insert the funnel provided in the loading drawer.

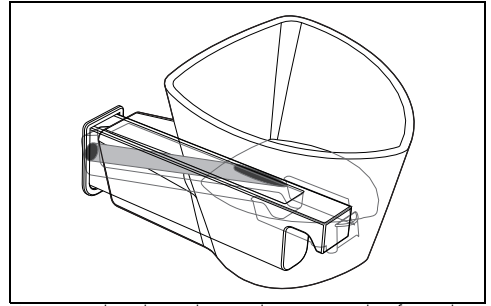

- Pour the descaling solution into the funnel.

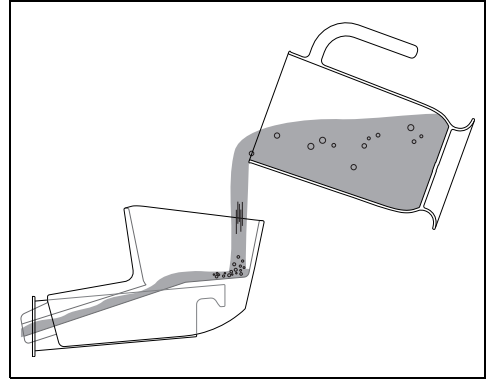

- At the end, remove the funnel and place the loading drawer back in its place.

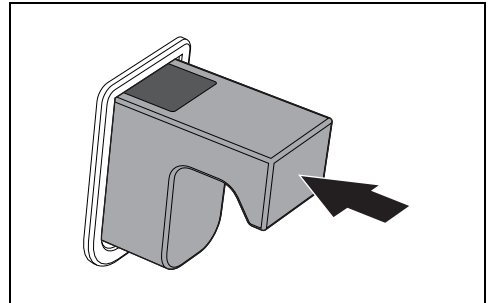

If there is too much water in the reservoir, the excess water will drain into the oven cavity. In this case dry with a cloth or sponge before proceeding.

### Descaling



- Close the door
- Press the temperature knob to start the function.



3. Descaling starts. The heating elements are activated for the first 10 minutes of the process.



 Each time the door is opened, the function in progress stops and then automatically restarts when the door is closed again.

4. After 10 minutes, the heating elements switch off (the indicator lights  and  switch off) while the descaling process continues for the next 50 minutes.





After completion of the descaling process, the appliance sounds an acoustic signal and the display shows the request to drain the descaling solution.



### Reservoir draining

1. Open the door
2. Place the deep pan on the third shelf from the bottom. Push it against the rear wall of the oven cavity. Press the temperature knob.

The descaling solution starts to flow into the deep pan from the drain pipe on the right side of the rear wall of the oven cavity.

3. Wait for the end of the exhaust flow (check that both level indicator lights   are switched off).

4. Press the temperature knob to stop the drain function.

5. Drain the descaling solution from the deep pan.

 Take care: the descaling solution may be still hot.

### Rinse

Once the descaling agent has been drained, the hydraulic circuit must be rinsed with clean water.

 Use cold tap water which is not too hard, softened water or still mineral water.

 Do not use distilled water, tap water with a high chloride content (> 40 mg/l), or other liquids.

The display will show the request to fill the reservoir with water.



1. Open the door.
2. Place the deep pan on the third shelf from the bottom. Push the tray up against the rear wall of the oven cavity.
3. Pull the loading drawer out of its housing.
4. Insert the funnel provided in the loading drawer.
5. Pour one litre of water using a bottle or a measuring jug.

 The overflowing of water inside the oven cavity is not intended as a malfunction, rather it is part of the rinsing procedure.

6. Press the temperature knob to start the function and wait one minute.



At the end, the appliance sounds an acoustic signal and the display shows the request to

drain the reservoir.



7. Press the temperature knob to drain the water from the reservoir into the deep pan.
8. Wait for the end of the exhaust flow (check that both level indicator lights  are switched off).
9. Press the temperature knob to stop the drain function.
10. Drain the water from the deep pan.  
The display shows the new request to fill the reservoir with water.



11. Place the deep pan on the third shelf from the bottom. Push it against the rear wall of the oven cavity.
12. Pour one litre of water into the funnel placed in the loading drawer (using a bottle or a graduated jug) until it has overflowed to the bottom of the cavity.
13. Press the temperature knob to start the function and wait one minute.

At the end, the appliance sounds an acoustic signal and the display shows the request to drain the reservoir.



14. Drain the water from the reservoir into the deep pan.
15. Wait for the end of the exhaust flow (check that both level indicator lights  are switched off).



16. Press the temperature knob to stop the drain function.

17. Drain the water from the deep pan.

18. Return the function knob to the 0 position.

### Sanitization

Sanitization with steam allows to remove the last residues of descaling from the hydraulic circuit.

1. Select the steam-assisted  +  function using the function knob.



2. Open the door
3. Pull the loading drawer out of its housing.
4. Insert the funnel provided in the loading drawer.
5. Pour 500 ml water (using a bottle or a measuring jug).
6. At the end, remove the funnel and place the loading drawer back in its place.
7. Close the door.
8. Press the temperature knob to start the function.
9. Press and turn the temperature knob to set the duration of 30 minutes



10. Wait a few seconds.
11. Press and hold the temperature knob for a few seconds to skip the preheating phase (the indicator light  stops flashing).
12. Wait for the function to be executed until the end.
13. When the function has finished, turn the function and temperature knobs to the 0 position.

 Take care: wait for the oven cavity to cool down.

14. Open the door

15. Place the deep pan on the third shelf from the bottom. Push it against the rear wall of the oven cavity.
16. After entering the special functions menu, turn the temperature knob until the Reservoir drain function is selected.
17. Press the temperature knob to confirm the function.
18. Press the temperature knob again to start the function.

The water starts to flow into the deep pan from the drain pipe on the right side of the rear wall of the oven cavity.

19. Wait for the end of the exhaust flow (check

that both level indicator lights  are switched off).

20. Press the temperature knob to stop the drain function.
21. At the end, return the function knob to the 0 position.
22. Drain the water from the deep pan.
23. Wipe off any spillage of water in the cooking compartment with a cloth or sponge.
24. Close the door.

## Extraordinary maintenance

### Seal maintenance tips

The seal should be soft and elastic.

- To keep the seal clean, use a non-abrasive sponge and wash with lukewarm water.

### Replacing the internal light bulb

 **Power voltage**  
**Danger of electrocution**

- Unplug the appliance.
- Wear protective gloves.

1. Completely remove all accessories from inside the oven.
2. Remove the rack/tray support frames.

3. Use a tool (e.g. a spoon) to remove the bulb cover.

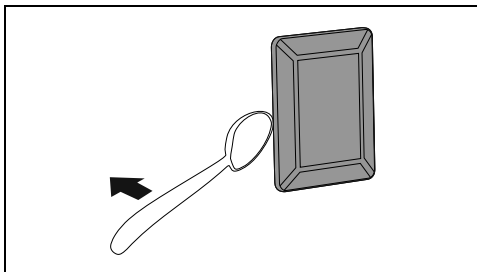

Take care not to scratch the enamel of the oven cavity wall.

4. Slide out and remove the light bulb.

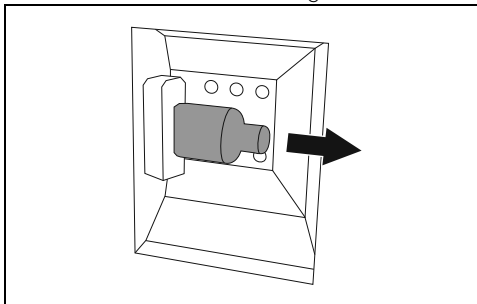

Do not touch the halogen light bulb directly with your fingers, use an insulating material.

5. Replace the light bulb with one of the same type (40 W).
6. Refit the cover. Ensure the moulded part of the glass (A) is facing the door.

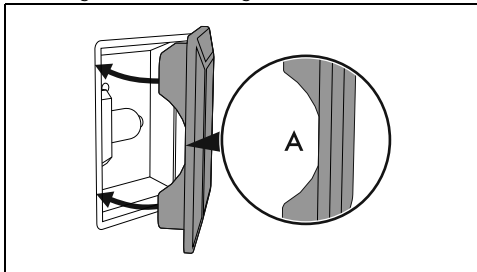

7. Press the cover completely down so that it attaches perfectly to the bulb support.

# INSTALLATION

## Electrical connection



See General safety instructions.

### General information

Check the mains characteristics against the data indicated on the plate.

The identification plate bearing the technical data, serial number and brand name is visibly positioned on the appliance.

Do not remove this plate for any reason.

The appliance must be connected to ground using a wire that is at least 20 mm longer than the other wires.

The appliance can work in the following modes:

- 220-240 V~

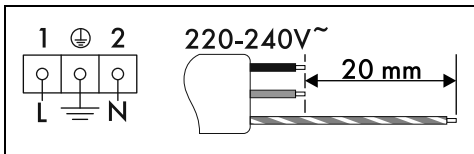

3 x 1.5 mm<sup>2</sup> three-core cable.



The values indicated above refer to the cross section of the internal lead.



The aforementioned power cables are sized taking into account the coincidence factor (in compliance with standard EN 60335-2-6).

### Fixed connection

Fit the power line with an all-pole circuit breaker with a contact separation distance sufficient to provide complete disconnection in category III overvoltage conditions, pursuant to installation regulations.

### For the Australian/New Zealand market:

The circuit breaker incorporated in the fixed connection must comply with AS/NZS 3000.

### Connection with plug and socket

Make sure that the plug and socket are of the same type.

Avoid using adapters, gang sockets or shunts as these could cause overheating and a risk of burns.

## Cable replacement



Power voltage  
**Danger of electrocution**

- Disconnect the mains power supply.
1. Unscrew the rear casing screws and remove the casing to access the terminal board.

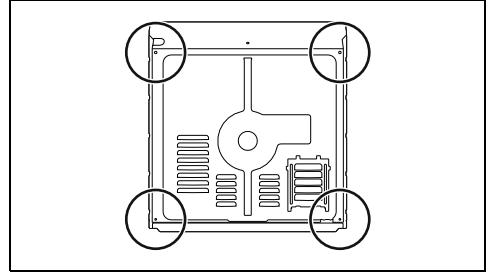

2. Replace the cable.
3. Make sure that the cables (for the oven or any hob) follow the best route in order to avoid any contact with the appliance.

## Positioning



See General safety instructions.

### Position of the power cable

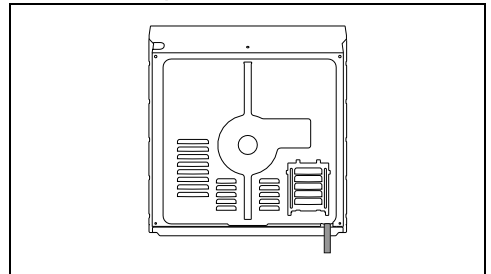

### Front panel seal

Glue the supplied seal to the rear part of the front panel to avoid water or other liquids from

leaking in.

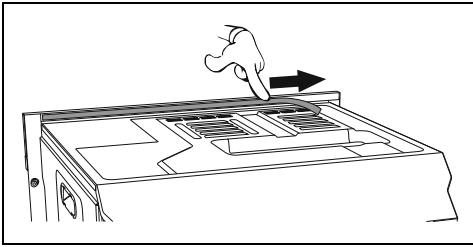

### Fastening bushings

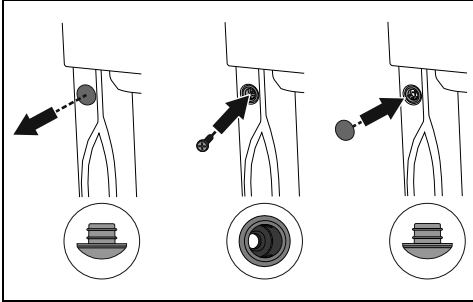

1. Remove the bushing covers on the front of the appliance.
2. Mount the appliance into the recess.
3. Secure the appliance to the cabinet using screws.
4. Cover the bushings with the previously removed covers.

### Appliance overall dimensions (mm)

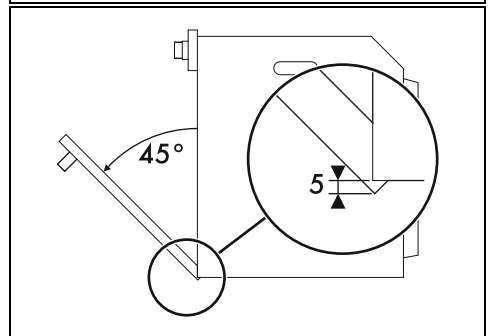
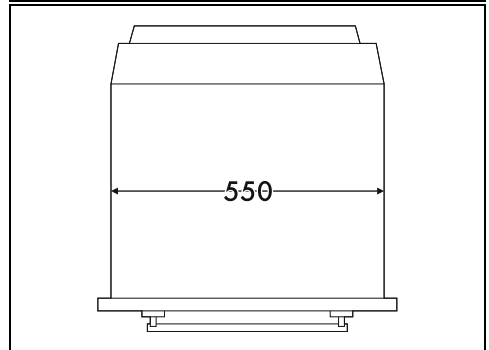
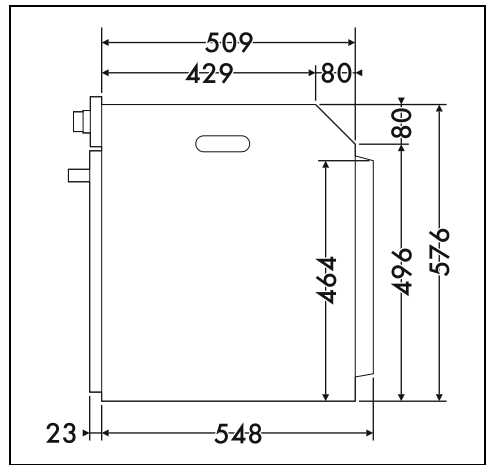
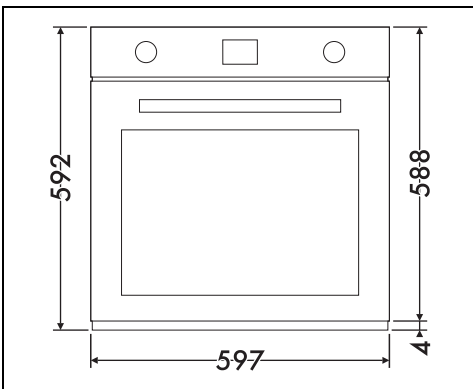

EN

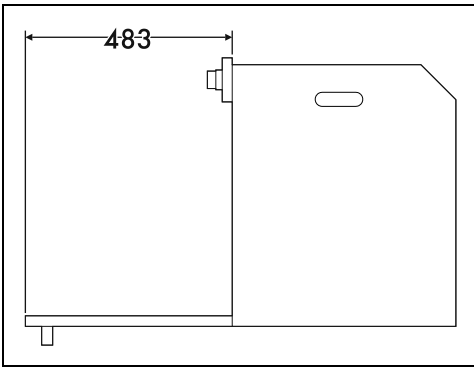

Mounting into a column (mm)

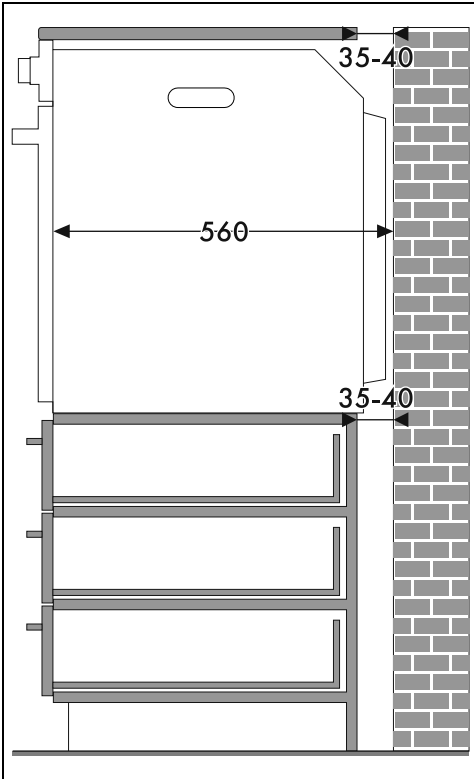

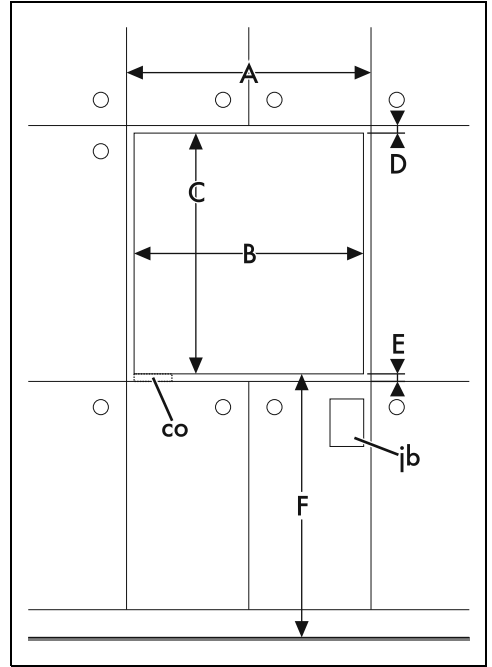
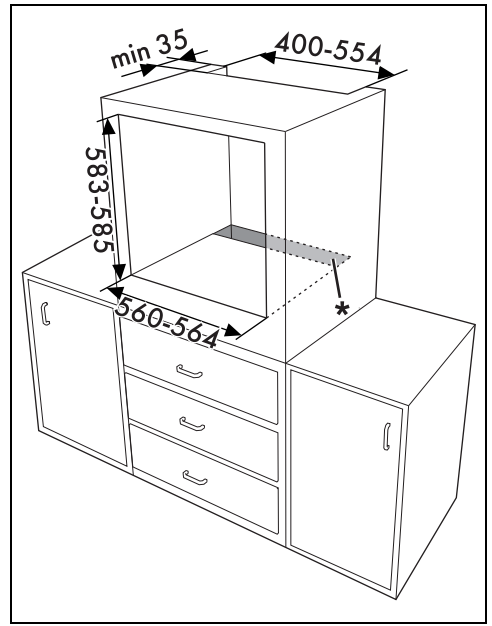

\* Make sure that the cabinet top/rear section has an opening approx. 35-40 mm deep.

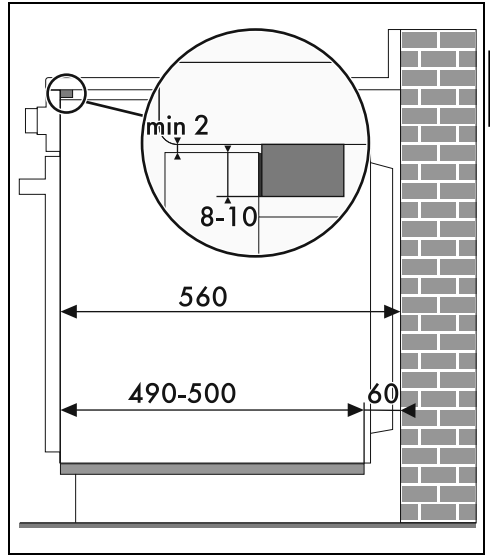
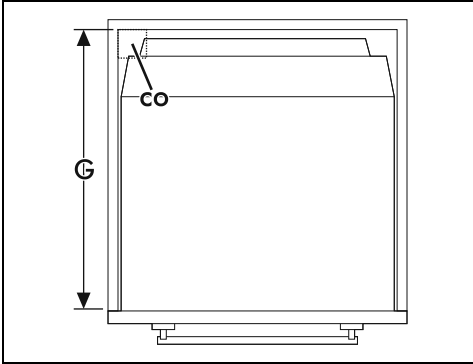
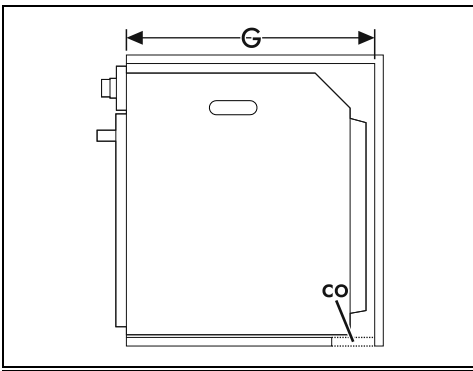

## Mounting under worktops (mm)

EN



 If the appliance is to be built-in under a worktop, a wooden bar has to be installed order to use the seal that is glued to the back of the front panel to prevent water or other liquids leaking in.

A min. 603 mm

B 560 - 564 mm

C 583 - 585 mm

D 9 - 11 mm

E min. 5 mm

F 121 - 1105 mm

G min. 560 mm

H min. 594 mm

co Cutout for power cord (min. 6 cm<sup>2</sup>)

jb Electrical connection box

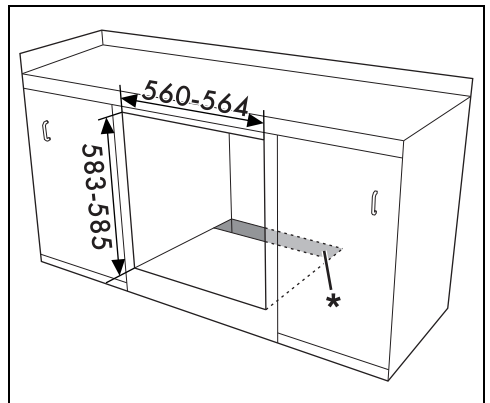

 \* Make sure that the piece of furniture top/rear part has an opening approx. 60 mm deep.

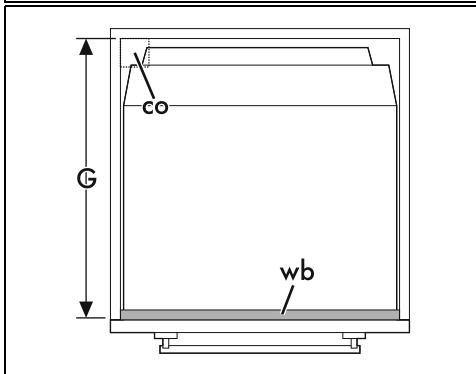
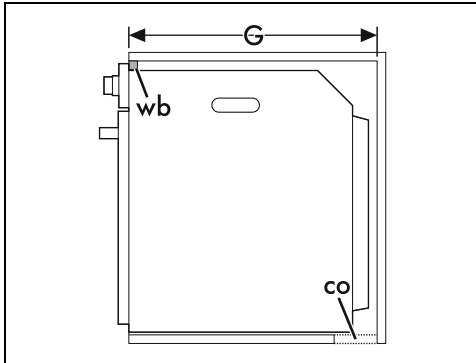
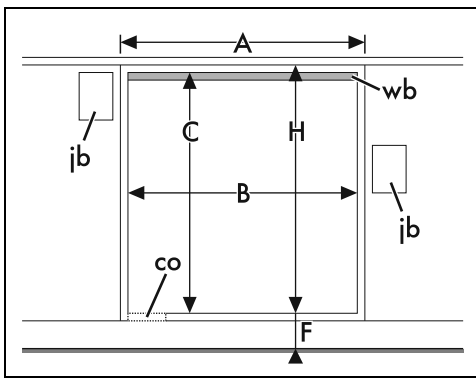

A min. 603 mm

B 560 - 564 mm

C 583 - 585 mm

D 9 - 11 mm

E min. 5 mm

F 121 - 1105 mm

G min. 560 mm

H min. 594 mm

co Cutout for power cord (min. 6 cm<sup>2</sup>)

jb Electrical connection box

wb Wooden bar (recommended)

### Mounting under worktops (mm) (pyrolytic models only)

Whenever a hob is installed above the oven, a wooden separator has to be installed at a minimum distance of 20 mm from the top of the oven to prevent overheating when the two appliances are used at the same time. It must only be possible to remove the separator by using suitable tools.

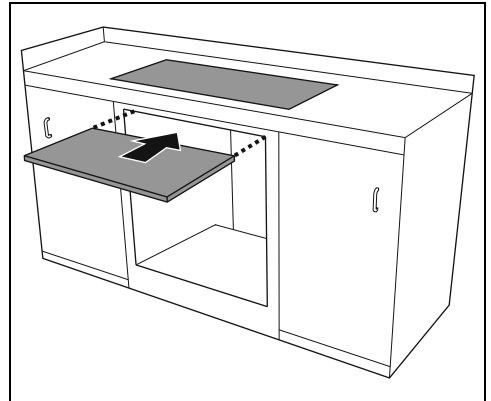



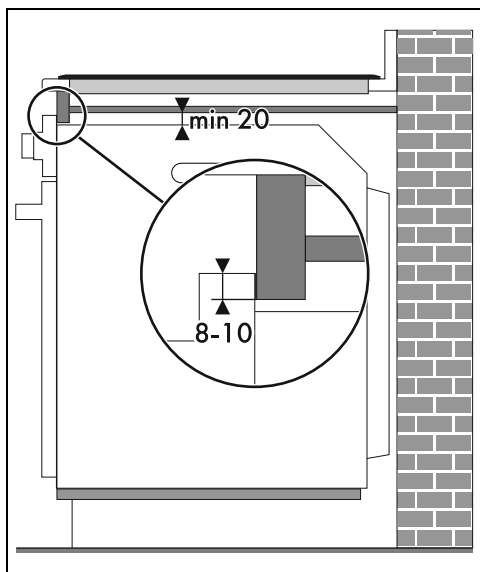

When using a wooden separator, a wooden bar has to be installed under the worktop in order to use the seal that is glued to the back of the front panel to prevent water or other liquids leaking in.