

FMA 86 H

EN User manual

TABLE OF CONTENTS

OVERVIEW	4
CONTROL PANEL.....	4
ACCESSORIES	5
FUNCTIONS	5
FIRST TIME USE.....	6
DAILY USE.....	6
USEFUL TIPS	7
COOKING TABLE.....	8
CLEANING AND MAINTENANCE.....	10
TROUBLESHOOTING	11
SUPPORT	11

USER GUIDE

OVERVIEW

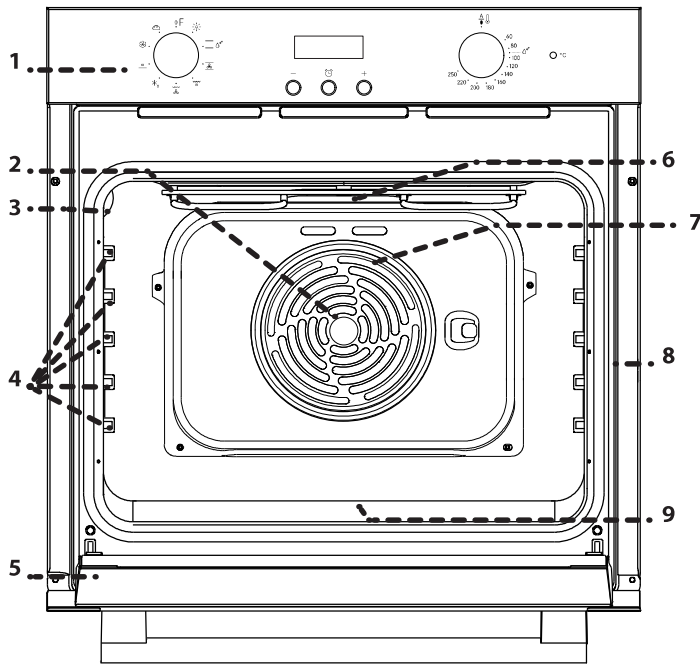

1. Control panel
2. Fan
3. Lamp
4. Shelf guides
(the level is indicated on the wall of the cooking compartment)
5. Door
6. Upper heating element / grill
7. Circular heating element
(not visible)
8. Identification plate
(do not remove)
9. Bottom heating element
(not visible)

CONTROL PANEL

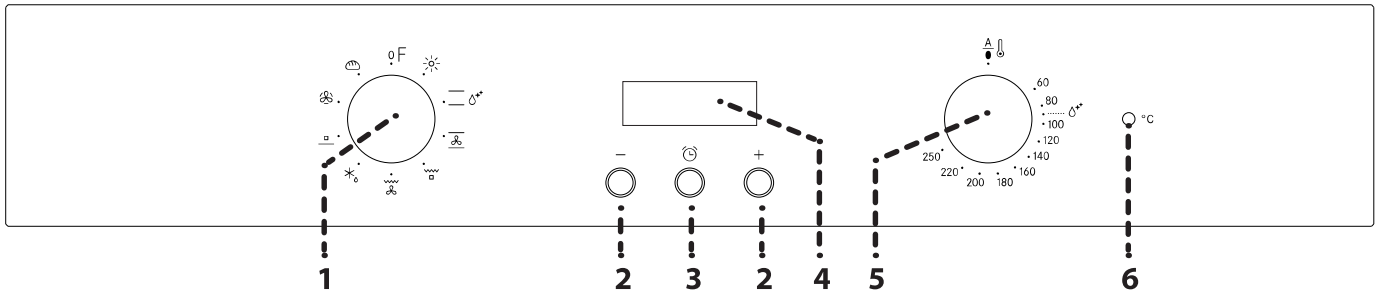

1. SELECTION KNOB

For switching the oven on by selecting a function. Turn to the 0 position to switch the oven off.

2. +/- BUTTON

To decrease or increase the value shown on the display.

3. TIME BUTTON

For selecting the various settings: duration, cooking end time, timer.

4. DISPLAY

5. THERMOSTAT KNOB

Turn to select the temperature you require.

6. LED THERMOSTAT / PREHEATING

Switches on during the heating process. Switches off once the desired temperature is reached.

ACCESSORIES

WIRE SHELF

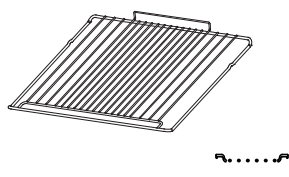

DRIP TRAY

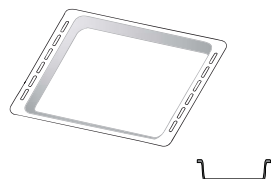

BAKING TRAY

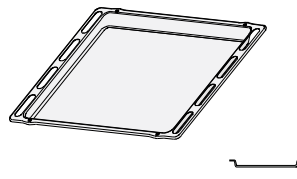

The number and type of accessories may vary depending on which model is purchased. Other accessories can be purchased separately from the After-sales Service.

INSERTING THE WIRE SHELF AND OTHER ACCESSORIES

- Insert the wire shelf onto the level you require by holding it tilted slightly upwards and resting the raised rear side (pointing upwards) down first. Next, slide it horizontally along the shelf guide as far as possible.

- The other accessories, such as the baking tray, are inserted horizontally by sliding them along the shelf guides.
- The shelf guides can be removed to facilitate the oven cleaning: pull them to remove from their seats.

FUNCTIONS

0 OFF
For switching off the oven.

LIGHT
For switching on the light in the compartment.

CONVENTIONAL
For cooking any kind of dish on one shelf only. It is better to use the 2nd shelf.

STEAM CLEANING
The action of the steam released during this special low-temperature cleaning cycle allows dirt and food residues to be removed with ease. Pour 200 ml of drinking water on the bottom of the oven and use the function for 35' at 90°C. Activate the function when the oven is cold and let it cool down for 15' once the cycle ends.

CONVECTION BAKE
For baking cakes with juicy fillings on a single shelf. This function can also be used for cooking on two shelves. Switch the position of the dishes to cook food more evenly.

GRILL
For grilling steaks, kebabs and sausages, cooking vegetables au gratin or toasting bread. When grilling meat, we recommend using a drip tray to collect the cooking juices: position the pan on any of the levels below the wire shelf and add 200 ml of drinking water.

TURBO GRILL
For roasting large joints of meat (legs, roast beef, chicken). We recommend using a drip tray to collect the cooking juices: position the pan on any of the levels below the wire shelf and add 500 ml of drinking water.

DEFROSTING
For defrosting food more quickly.

BOTTOM HEATING
Useful for browning the base of the dish. This function is recommended also for slow-cooking, for finishing the cooking of juicy dishes, and making sauce concentrates.

FORCED AIR
For cooking different foods that require the same cooking temperature on several shelves (maximum three) at the same time. This function can be used to cook different foods without odours being transferred from one food to another.

BREAD
To bake different types and sizes of bread. It is better to use the 2nd shelf.

FIRST TIME USE

1. SETTING THE TIME

You will need to set the time of the day when you switch on the appliance for the first time: "AUTO" and "0.00" flash on the display.



To set the time of day, press buttons — and + at the same time: Set the time of day using the + and — buttons.

Press the *time button* to confirm.

Having selected the desired time value, it is possible to change the alarm tone: the display shows "ton 1".



To select the desired tone, press button —, then press the *time button* to confirm.

Please note: To change the time of the day afterwards for example following lengthy power outages, proceed as described above.

2. HEAT THE OVEN

A new oven may release odours that have been left behind during manufacturing: this is completely normal.

Before starting to cook food, we therefore recommend heating the oven with it empty in order to remove any possible odours.

Remove any protective cardboard or transparent film from the oven and remove any accessories from inside it.

Heat the oven to 250° C for about one hour, preferably using the "Convection bake" function. The oven must be empty during this time.

Follow the instructions for setting the function correctly.

Notes: It is advisable to air the room after using the appliance for the first time.

DAILY USE

1. SELECT A FUNCTION

To select a function, turn the *selection knob* to the symbol for the function you require.

2. ACTIVATE A FUNCTION

MANUAL

To start the function you have selected, turn the *thermostat knob* to set the temperature you require.

To interrupt the function at any time, switch off the oven, turn the *selection knob* and the *thermostat knob* to **0**.

STEAM CLEANING

To activate the "Steam Cleaning" cleaning function, pour 200 ml of drinking water into the bottom of the oven, then turn the *selection knob* and the *thermostat knob* to the Δ^+ icon.

It is best to use the function for 35'.

3. PREHEATING

Once the function has been activated, the LED thermostat will switch on signalling that the preheating process has begun.

At the end of this process, the LED thermostat switches off indicating that the oven has reached the set temperature: At this point, place the food inside and proceed with cooking.

Please note: Placing the food in the oven before preheating has finished may have an adverse effect on the final cooking result.

. USING THE ELECTRONIC PROGRAMMER

By pressing the *time button* it is possible to select various mode to keep or program the cooking time.

Please note: After few seconds without any interaction, a buzzer sounds and all settings will be confirmed.

1. Button — : to decrease the value shown on the display
2. Button \odot : for selecting the various settings
3. Button +: to increase the value shown on the display

A. The symbol Δ indicates that the timer function is in operation

B. The **AUTO** symbol confirms the setting has been made

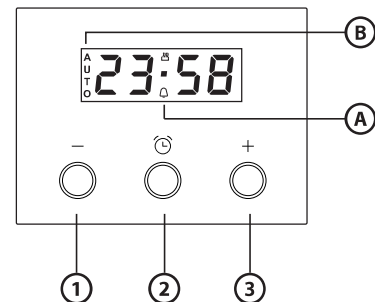

. PROGRAMMING COOKING

After selecting and activating the function, it is possible to set the duration.

DURATION

Press for at least 2 seconds the *time button*: the Δ symbol flashes.



Press the *time button* again: the display shows DUR and 0.00 in sequence while AUTO flashes.

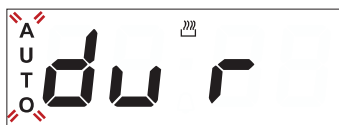

Set the duration using the buttons + and -. After a few seconds, the display shows the time of the day while AUTO  remain lit, confirming the setting.



Please note: To view the remaining cooking duration press the *time button* for at least 2 seconds. To change it, if necessary, press it again a second time, using + and - buttons to modify the duration.

COOKING END

At the end of cooking, the symbol  switches off, an alarm sounds while AUTO flashes on the display.

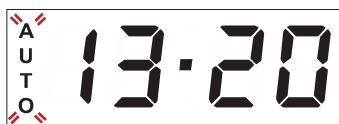

Press any button to deactivate the alarm.

Return the function knob and *thermostat knob* to 0 and ●, then press the *time button* for at least 2 seconds to switch off the oven.

PROGRAMMING THE END COOKING TIME/DELAYED START

After selecting duration, press the *time button*: the display shows END, cooking end time and AUTO flashing in sequence.



Press the button + to select the desired cooking end time.

After a few seconds the display shows the time of the day, the symbol  switches off and AUTO remains lit, confirming the setting.



Please note: To view cooking end time and change it if necessary, press the *time button* 2 seconds, then press it again twice.

The function will remain paused until the symbol  lights up and the oven proceeds automatically with the selected cooking mode after the period of time that has been calculated in order for cooking to finish at the time you have set.

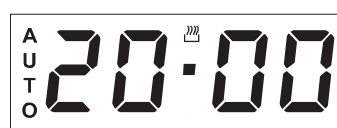

SETTING THE TIMER

This option does not interrupt or activate cooking but allows you to use the display as a timer, both while a function is active and when the oven is off.

To activate the timer, press the *time button* for at least 2 seconds: the  symbol flashes on the display.



Use the + and - buttons to set the desired duration: the countdown begins after a few seconds.



The display shows the time of the day and the  remains lit, confirming the timer has been set.

Please note: To view the countdown and change it if necessary, press again the *time button* for at least 2 seconds.

USEFUL TIPS







































































HOW TO READ THE COOKING TABLE





The table lists the best function, accessories and level to use to cook different types of food. Cooking times start from the moment the food is placed in the oven, excluding preheating (where required). Cooking temperatures and times are approximate and depend on the amount of food and the type of accessory used. Use the lowest recommended settings to begin with and, if the food is not cooked enough, then switch to higher settings. Use the accessories supplied and preferably dark-coloured metal cake tins and baking trays. You can also use Pyrex or stoneware pans and accessories, but bear in mind that cooking times will be slightly longer.













































COOKING DIFFERENT FOODS AT THE SAME TIME

Using the "Forced Air" function, you can cook different foods which require the same cooking temperature at the same time (for example: fish and vegetables), on different levels. Remove the food which requires a shorter cooking time and leave the food which requires a longer cooking time in the oven.

COOKING TABLE

RECIPE	FUNCTION	PREHEAT	TEMPERATURE (°C)	DURATION (MIN)	LEVEL AND ACCESSORIES
Leavened cakes		Yes	150 - 170	30 - 90	
		Yes	160 - 180	30 - 90	 
Filled cakes (cheese cake, strudel, fruit pie)		Yes	160 - 200	35 - 90	
		Yes	160 - 200	40 - 90	 
Biscuits / tartlets		Yes	160 - 180	15 - 35	
		Yes	150 - 170	20 - 45	 
		Yes	150 - 170	20 - 45	  
Choux buns		Yes	180 - 200	40 - 60	
		Yes	170 - 190	35 - 50	 
Meringues		Yes	90	150 - 200	
		Yes	90	140 - 200	 
		Yes	90	140 - 200	  
Pizza / Bread		Yes	220 - 250	10 - 25	
		Yes	200 - 240	20 - 45	 
Small bread 80 g		Yes	180 - 200	30 - 45	
Bread loaf 500 g		Yes	180	50 - 70	
Bread		Yes	180 - 200	30 - 80	 
Frozen pizza		Yes	250	10 - 20	
		Yes	230 - 250	10 - 25	 
Savoury cake (vegetable pie, quiche)		Yes	180 - 200	30 - 45	
		Yes	180 - 200	35 - 50	 
		Yes	180 - 200	35 - 50	  
Vol-au-vent / Puff pastry cakes		Yes	190 - 200	20 - 30	
		Yes	180 - 190	20 - 40	 
		Yes	180 - 190	20 - 40	  
Lasagne / baked pasta / cannelloni / flans		Yes	190 - 200	45 - 65	

ACCESSORIES					
	Wire shelf	Baking dish or cake tin on the wire shelf	Baking tray or cake tin on the wire shelf	Baking tray with 200 ml of water	Baking tray

RECIPE	FUNCTION	PREHEAT	TEMPERATURE (°C)	DURATION (MIN)	LEVEL AND ACCESSORIES
Lamb / veal / beef / pork 1 kg		Yes	190 - 200	80 - 110	2 
Roast pork with crackling 2 kg		Yes	180 - 190	110 - 150	2 
Chicken / rabbit / duck 1 kg		Yes	180 - 200	50 - 100	2 
Turkey / goose 3 kg		Yes	180 - 200	50 - 100	2 
Baked fish / en papillote 0.5 kg (fillet, whole)		Yes	170 - 190	30 - 45	2 
Stuffed vegetables (tomatoes, courgettes, aubergines)		Yes	180 - 200	50 - 70	2 
Toasted bread		5'	250	2 - 6	5 
Fish fillets / slices		5'	250	15 - 30 *	4  3 
Sausages / kebabs / spare ribs / hamburgers		5'	250	15 - 30 *	5  4 
Roast chicken 1-1.3 kg		-	200 - 220	60 - 80 **	3  1 
Roast beef rare 1 kg		-	200	35 - 50 **	3 
Leg of lamb / knuckle		-	200	60 - 90 **	3 
Roast potatoes		-	200 - 220	35 - 55 **	3 
Vegetable gratin		-	200 - 220	25 - 55	3 
Meat and potatoes		Yes	190 - 200	45 - 100 ***	4  1 
Fish and vegetables		Yes	180	30 - 50 ***	4  1 
Lasagna and meat		Yes	200	50 - 100 ***	4  2 
Complete meal Fruit tart (Level 5) / Lasagna (Level 3) / Meat (Level 1)		Yes	180 - 190	40 -120 ***	5  3  1 

* Turn food halfway through cooking

** Turn food two-thirds of the way through cooking (if necessary).

*** Estimated length of time: dishes can be removed from the oven at different times depending on personal preference.

FUNCTIONS						
	Conventional	Grill	Turbo Grill	Forced Air	Convection Bake	Bread

CLEANING AND MAINTENANCE

Do not use steam cleaning equipment.

Use protective gloves during all operations.

Carry out the required operations with the oven cold.

Disconnect the appliance from the power supply.

Do not use wire wool, abrasive scourers or abrasive/corrosive cleaning agents, as these could damage the surfaces of the appliance.

EXTERIOR SURFACES

- Clean the surfaces with a damp microfibre cloth. If they are very dirty, add a few drops of pH-neutral detergent. Finish off with a dry cloth.
- Do not use corrosive or abrasive detergents. If any of these products inadvertently comes into contact with the surfaces of the appliance, clean immediately with a damp microfibre cloth.

INTERIOR SURFACES

- After every use, leave the oven to cool and then clean it, preferably while it is still warm, to remove any deposits or stains caused by food residues. To dry any condensation that has formed as a result of cooking foods with a high water content, allow the oven to cool completely and then wipe it with a cloth or sponge.

- Activate the "Steam Cleaning" function for optimum cleaning of the internal surfaces.
- The door can be easily removed and refitted to facilitate cleaning of the glass.
- Clean the glass in the door with a suitable liquid detergent.
- The top heating element of the grill can be lowered to clean the upper panel of the oven.

ACCESSORIES

Soak the accessories in a washing-up liquid solution after use, handling them with oven gloves if they are still hot. Food residues can be removed using a washing-up brush or a sponge.

REMOVING AND REFITTING THE DOOR

1. To remove the door, open it fully and lower the catches until they are in the unlock position.

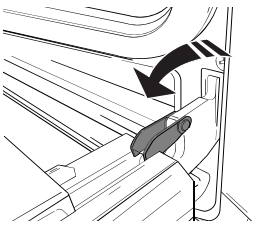

2. Close the door as much as you can. Take a firm hold of the door with both hands – do not hold it by the handle. Simply remove the door by continuing to close it while pulling it upwards (a) at the same time until it is released from its seating (b).

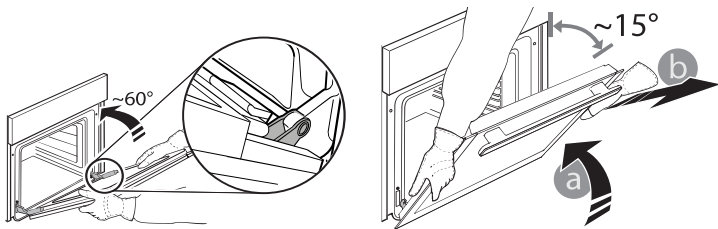

Put the door to one side, resting it on a soft surface.

3. Refit the door by moving it towards the oven, aligning the hooks of the hinges with their seating and securing the upper part onto its seating.
4. Lower the door and then open it fully. Lower the catches into their original position: Make sure that you lower them down completely.
5. Try closing the door and check to make sure that it lines up with the control panel. If it does not, repeat the steps above.

PRESS TO CLEAN - CLEANING THE GLASS

1. After removing the door and resting it on a soft surface with the handle downwards, simultaneously press the two retaining clips and remove the upper edge of the door by pulling it towards you.

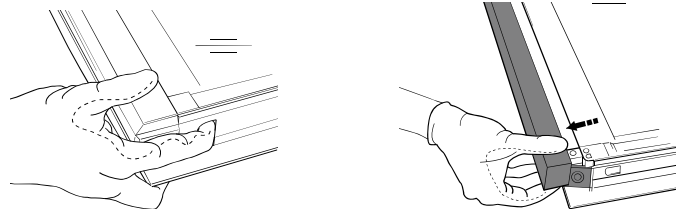

2. Lift and firmly hold the inner glass with both hands, remove it and place it on a soft surface before cleaning it.
3. To correctly reposition the inner glass, make sure that the "R" is visible in the left-hand corner. First insert the long side of the glass indicated by "R" into the support seats, then lower it into position.

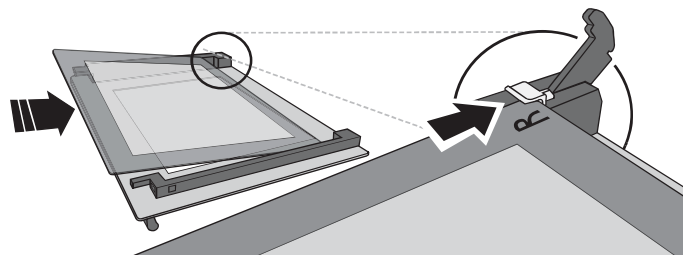

4. Refit the upper edge: a click will indicate correct positioning. Make sure the seal is secure before refitting the door.

REPLACING THE LAMP

1. Disconnect the oven from the power supply.
2. Remove the cover from the light, replace the bulb and put the cover back on the light.
3. Reconnect the oven to the power supply.

Please note: Only use 20-40 W/230 ~ V type G9, T300°C halogen bulbs. The bulb used in the product is specifically designed for domestic appliances and is not suitable for general room lighting within the home (EC Regulation 244/2009). Light bulbs are available from our After-sales Service.

- If using halogen bulbs, do not handle them with your bare hands as your fingerprints could cause damage. Do not use the oven until the light cover has been refitted.

TROUBLESHOOTING

Problem	Possible cause	Solution
The oven does not work.	Power cut. Disconnection from the mains.	Check for the presence of mains electrical power and whether the oven is connected to the electricity supply. Turn off the oven and restart it to see if the fault persists.

WWW.FRANKE.COM

© Franke Technology and Trademark Ltd, Switzerland

SUPPORT

In the event of any operation problems, contact a Franke Technical Service Centre.

Never use the services of unauthorized technicians.

Specify:

- the type of fault
- the appliance model (art./Code)
- the serial number (S.N.) on the rating plate, located on the right hand edge of the oven cavity (visible when the oven door is open).

When contacting our Service Centre, please state the codes provided on your product's identification plate.

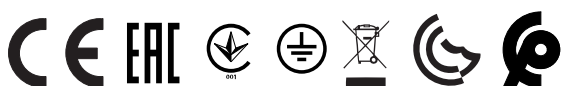
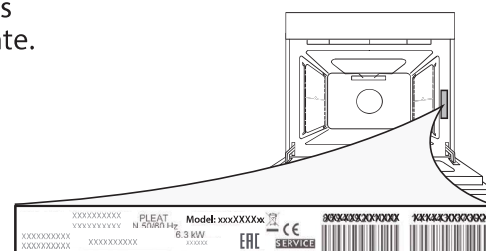

www.franke.com



EN

400011547027/C

